

# FIBER-OPTIC SENSORS

High precision in small spaces

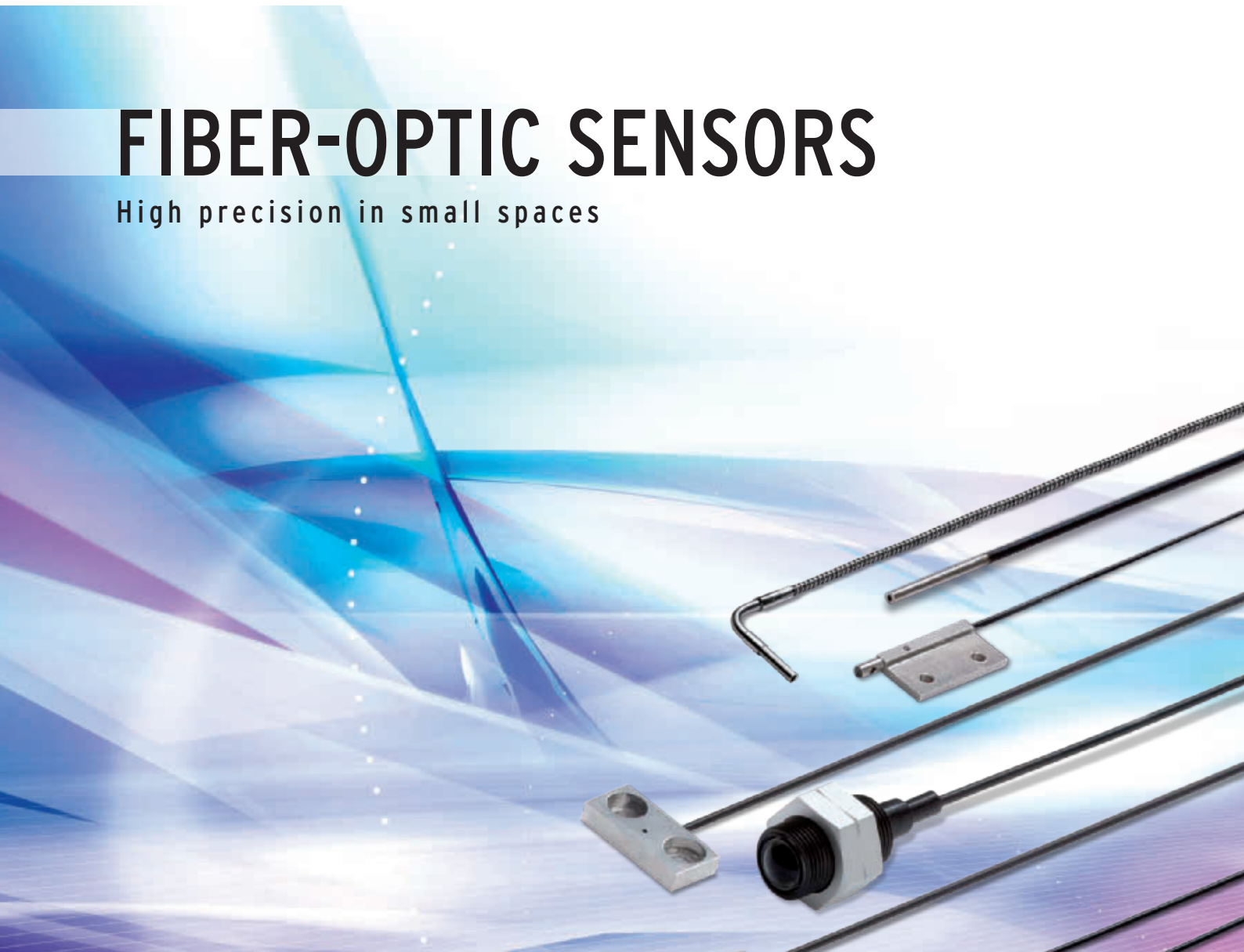

» Long operational life

» Wide portfolio range

» Easy to install and set up

# Precision and performance you can rely on

*For over 30 years OMRON has been a supplier of fiber optic solutions to leading manufacturers, especially in the semiconductor, the consumer electronics and the car electronics industry, as well as for food packaging and small plastic parts production.*

*The requirements for fiber optic solutions can be very demanding particularly for applications with extreme temperatures and aggressive chemicals for applications requiring highest precision in combination with limited mounting space or for applications requiring the reliable detection of a wide range of objects with different materials, shapes or colours.*

Today, already with over 500 standard, application or customer specific fiber optic sensors, we take pride in working together with you to ensure the best performance fit for your application.

Our global manufacturing network for fiber optic sensors in Ayabe (Japan), Shanghai (China) and Nufringen (Germany) focuses on continuously optimising methods for small and large volume production, applying stringent quality control procedures, and expanding production portfolio and flexibility to meet our customers' demands for flexibility, operational reliability, high accuracy and best application fit of our fiber optic sensors. Our goal is to provide precision and performance you can rely on.

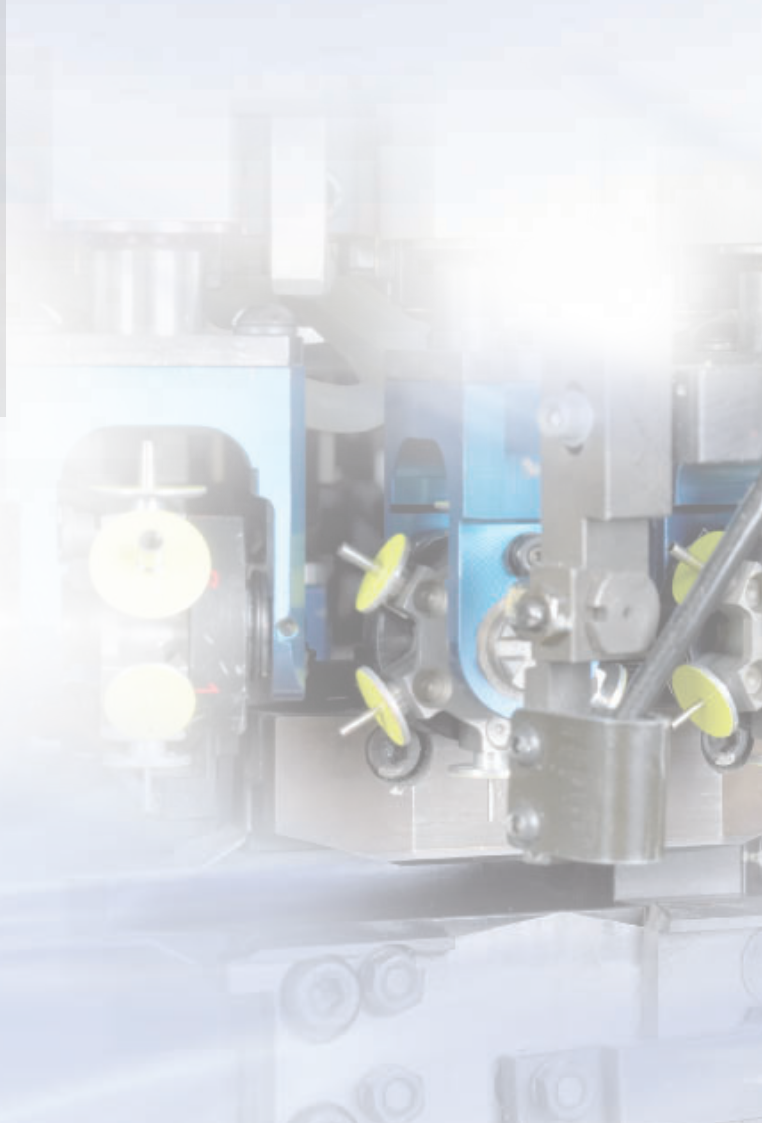

# Performance that makes a difference



## Long operational lifetime

Ensuring that products do not fail during production and require only minimal service attention enhances productivity and reduces maintenance costs.

### 1. Models with enhanced protection and tested resistance against harsh environments

- Tested resistance against aggressive chemicals, extreme temperatures, low pressure (vacuum), mechanical abuse

### 2. Preventing fiber breakage

- Housing construction preventing protruding cables (e.g. square shape, side view models)
- High flex fibers with 1mm bending radius for close wall mounting
- Robot fibers tested with more than one million bending cycles
- Protective metal or plastic tubes

### 3. Operational stability

- LED power control against aging effects
- Auto-threshold control for enhanced compensation of power decrease, e.g. through dirt on lenses



## Easy to set up and adjust

With minimal time required for mounting the fibers the productivity can be enhanced for machine builders and the easy setting of the amplifiers simplifies production changes for machine users.

### 1. Easy-teach amplifiers or manual adjusters

- Easy manual adjustment by potentiometer
- One-button auto teach for in-process dynamic teaching, or two-point object teaching

### 2. Wide range of easy-to-mount fibers

- One-screw-mount fibers with hexagonal back
- Square shapes for simple surface mounting
- Side view for simple alignment
- Application-optimised housings (e.g. fork shape for label and foil detection, tube for liquid level detection, etc.)



## High accuracy in smallest size

OMRON's precise manufacturing processes with inspection system supported alignment of the fibers and lenses achieve minimal tolerance variations in all standard models and allow the detection of the smallest objects and height differences of less than 100µm.

- High beam axis accuracy for side view models through precise fiber bending or angle mirror surface treatment
- High spot evaluation precision on coaxial models through equal fiber distribution
- Accurate distance setting through precise lens and beam alignment



# The little extra

For your advanced application requirements, adaption to specific settings, or special solutions, our sales, application and engineering teams near you will provide additional service and support....what can we do for you?



## Application solution support

- Product selection and configuration support for best application fit and value for money
- Best practice tips & tricks for highest operational stability

## Product modifications

- Fiber length, material and type adaptations
- Fiber head material modifications



## Advanced connectivity and communication

- Remote teach
- Online parameter monitoring
- Connecting the amplifiers via field bus

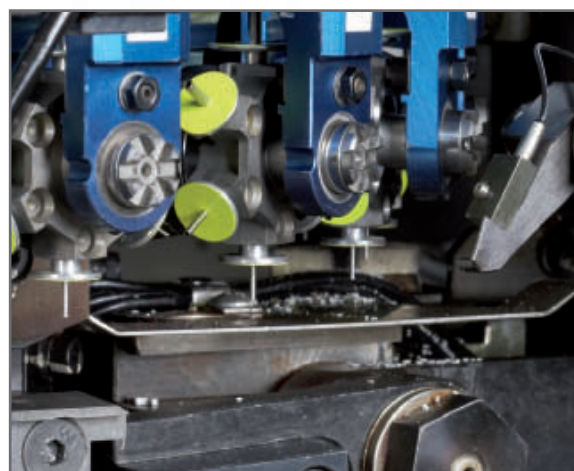

## Special solutions

- Application-specific configurations of focal lens, mounting head and fiber type
- Application-specific software, or parameter pre-configurations



# Choose the performance you need

## STEP 1: The fiber optic sensor heads

### General application



Standard cylindrical



Square shape



Miniature



Long distance

### Enhanced environment resistance



Chemical resistant



Heat resistant

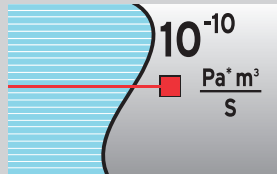

Vacuum resistant

### Special objects or installations

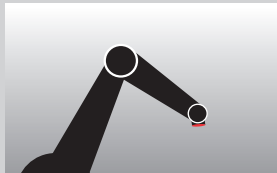

Robotic usage



Precision detection

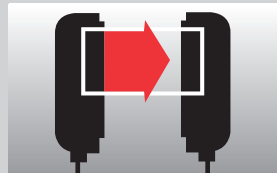

Area monitoring

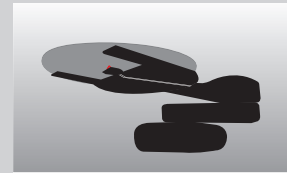

Special detection

### Accessories

Lenses, protective tubes, reflectors, installation aids

## STEP 2: The amplifiers

### Easy usage amplifier

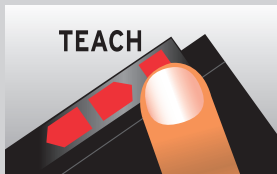

Easy-teach

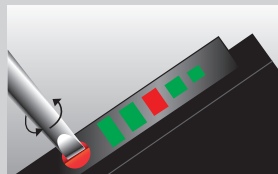

Potentiometer adjuster

### Advanced functionality amplifiers

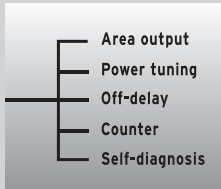

High Functionality

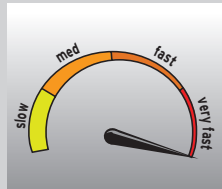

High speed



Colour detection

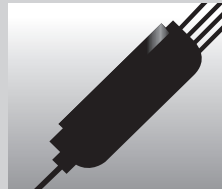

Double amplifier

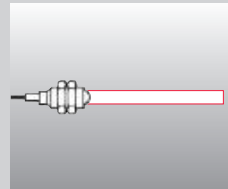

Infrared LED

## STEP 3: The little extra

### The little extra

Application solution support, advanced connectivity and communication, modifications and special solutions.

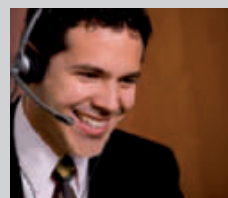

6

12

16

22

23

26



### Standard cylindrical fiber sensor heads

The standard cylindrical fiber optic sensing heads provide reliable object detection, easy installation and long sensor lifetime for all general applications.

- High-flex fibers and 90° cable exit for fiber breakage prevention
- Models with hexagonal back for simplified one-nut mounting
- Sizes M3 to M6

### Ordering information

Sensor type	Size	Sensing distance (in mm) <sup>*1</sup>		Order code	
		Standard	High-flex	Standard	High-flex
	M4	760	530	E32-TC200 2M	E32-ET11R 2M
	M3	220	130	E32-TC200E 2M	E32-ET21R 2M
	dia 4 mm	760	–	E32-ETC220 2M	–
	M4	–	530	–	E32-T11N 2M
	M6	250 <sup>*2</sup>	–	E32-R21	–
	M6	300	170	E32-DC200 2M	E32-ED11R 2M
	M4	80	30	E32-D211 2M	E32-D211R 2M
	M3	80	30	E32-DC200E 2M	E32-ED21R 2M
	M6	–	170	–	E32-D11N 2M
	dia 6 mm	110	45	E32-D14L 2M	E32-D14LR 2M

<sup>\*1</sup> Sensing distance measured with E3X-DA-SE-S family. Longer sensing distance up to 80% can be achieved with E3X-DA-S.

<sup>\*2</sup> Measured with E39-R3

### Specifications

Item	Standard					High Flex				
	E32- C200 E32- C220	E32-D14L	E32- C200E	E32-D211	E32-R21	E32-E_R	E32-D14LR	E32-D211R	E32- _11N	
Permissible bending radius	R25		R10		R1					
Cut to length	Yes									
Ambient temperature	-40°C to 70°C									
Material	Head	Brass-nickel plated	Stainless steel	Brass-nickel plated	Stainless steel	Plastic (ABS)	Brass-nickel plated	Stainless steel	Brass-nickel plated	
	Fiber	PMMA								
	Sheath	Polyethylene coating					PVC coating			
Degree of protection	IEC 60529 IP67									

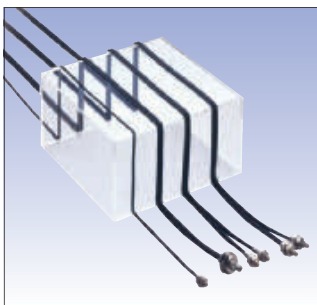

Hi-flex multicore fibers for flexibility in installation without fiber breakage

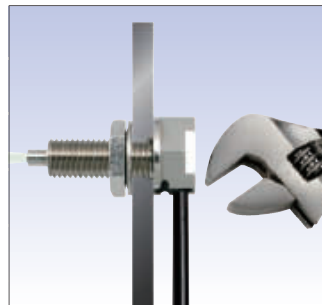

Models with hexagonal back for simple one-nut mounting

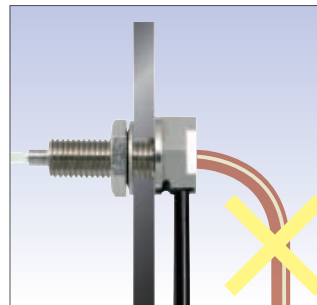

Cable exit shifted by 90° for preventing fiber breakage



### Square shape fiber sensor heads

The fiber heads in square shaped housing provide fast and easy installation on flat surfaces.

- Models with sensing direction in X, Y or Z axis
- 3 or 4mm thick housings for minimal height requirement
- Standard or high-flex fibers

### Ordering information

Sensor type	Size (in mm) (Standard/High-flex)	Sensing distance (in mm) *1		Order code	
		Standard	High-flex	Standard	High-flex
	15x8x3/ 15x10x4	760	560	E32-T15X 2M	E32-ETS10R 2M
	15x8x3	460	210	E32-T15Y 2M	E32-T15YR 2M
	15x8x3/ 15x9x4	460	480	E32-T15Z 2M	E32-ETS14R 2M
	15x10x3	300	170	E32-D15X 2M	E32-D15XR 2M
	15x10x3	100	40	E32-D15Y 2M	E32-D15YR 2M
	15x10x3/ 13x6x2.3	100	60	E32-D15Z 2M	E32-EDS24R 2M
	24.5x10x3	890	–	E32-A03-1 2M	–
	20.5x2x2	340	–	E32-A04-1 2M	–

\*1 Sensing distance measured with E3X-DA-SE-S family. Longer sensing distance up to 80% can be achieved with E3X-DA-S.

### Specifications

Item	Standard			High flex	
	E32- <u>15</u>	E32-A03- <u>  </u>	E32-A04- <u>  </u>	E32-E	E32- <u>15</u> _R
Permissible bending radius	R25	R10		R1	
Cut to length	Yes				
Ambient temperature	-40°C to 70°C				
Material	Head	Aluminium	Brass-nickel plated	Stainless steel	Aluminium
	Fiber	PMMA			
	Sheath	Polyethylene coating			PVC coating
Degree of protection	IEC 60529 IP67	IEC 60529 IP50		IEC 60529 IP67	

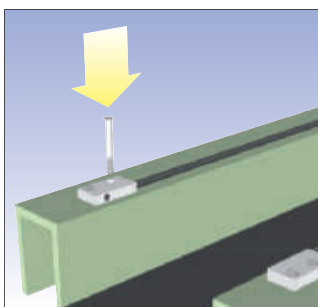

Space saving and fast mounting without additional brackets

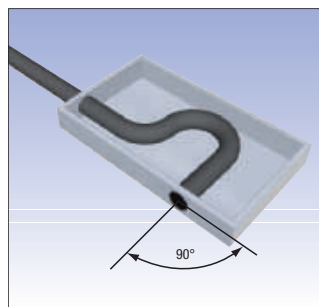

Precise positioning during manufacturing for 90° optics to achieve minimal tolerance variations in optical output axis angle





## Miniature fiber sensor heads

The miniature fiber heads provide high accuracy in smallest spaces and reliable detection of minute objects.

- Sizes from dia 500 µm to 3 mm
- Side view models with precision axis alignment for highest accuracy
- Bendable sleeves for precision positioning

### Ordering information

Sensor type	Size	Sensing distance (in mm) <sup>*1</sup>		Order code	
		Standard	High-flex	Standard	High-flex
	dia 3 mm	750	530	E32-T12 2M	E32-T12R 2M
	dia 2 mm	220	130	E32-T22 2M	E32-T22R 2M
	dia 1.5 mm	220	130	E32-T222 2M	E32-T222R 2M
	dia 1 mm	–	130	–	E32-T223R 2M
	dia 3 mm	460	210	E32-T14L 2M	E32-T14LR 2M
	dia 2 mm	340	–	E32-A04 2M	–
	dia 1 mm	130	50	E32-T24	E32-T24R 2M
	dia 1.2 mm	750	530	E32-TC200B	E32-TC200BR
	dia 0.9 mm	220	130	E32-TC200F	E32-TC200FR
	dia 3 mm	80	30	E32-D22 2M	E32-D22R 2M
	dia 2 mm	75	40	E32-D32 2M	E32-D32R 2M
	dia 1.5 mm	–	30	–	E32-D22B 2M
	dia 2 mm	30	15	E32-D24	E32-D24R 2M
	dia 2.5 mm	300	170	E32-DC200B 2M <sup>*3</sup>	E32-DC200BR <sup>*3</sup>
	dia 1.2 mm	80	30	E32-DC200F	E32-DC200FR
	dia 0.8 mm	–	16	–	E32-D33 2M
	dia 0.5 mm	–	3	–	E32-D331 2M

<sup>\*1</sup> Sensing distance measured with E3X-DA-SE-S family. Longer sensing distance up to 80% can be achieved with E3X-DA-S.

<sup>\*2</sup> Models with 40 mm sleeve instead of 90 mm sleeve are available by adding '4' to the order code at the end, e.g. E32-TC200B4

<sup>\*3</sup> Sleeve cannot be bent

**Specifications**

Item	Standard						High-flex				
	E32-DC200B E32-T12 E32-TC200B	E32-T14L	E32-D32	E32-D22 E32-T222 E32-TC200F	E32-D24 E32-DC200F E32-T22 E32-T24	E32-A04	E32-D32R E32-D33 E32-D331	E32-D22B	E32-DC200BR E32-T12R E32-TC200BR	E32-D22R E32-T222R E32-TC200FR	E32-D24R E32-DC200FR E32-T14LR E32-T22R E32-T223R E32-T24R
Permissible bending radius	R25			R10			R4		R1		
Cut to length	Yes										
Ambient temperature	-40°C to 70°C										
Material	Head	Brass-nickel plated	Stainless steel		Brass-nickel plated	Stainless steel			Brass-nickel plated	Stainless steel	
	Fiber	PMMA									
	Sheath	Polyethylene coating		PVC and polyethylene	Polyethylene coating			PVC and polyethylene	PVC coating		Polyethylene coating
Degree of protection	IEC 60529 IP67					IEC 60529 IP50		IEC 60529 IP67			

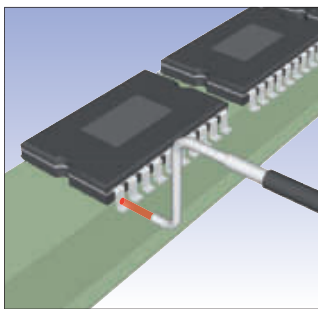

Bendable metal sleeves for precision positioning of sensors after installation

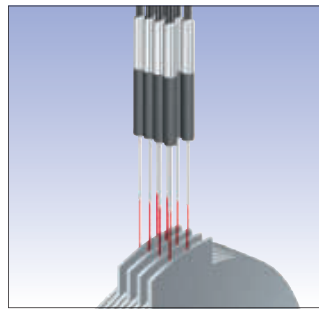

0.5 mm diameter (diffuse reflective) or 1 mm diameter (through beam) when mounting space is crucial

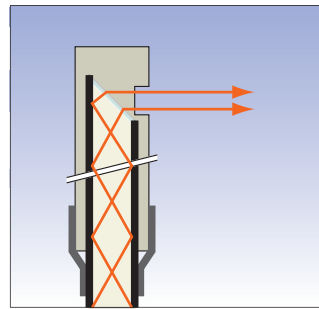

High precision fiber surface cutting and positioning during manufacturing to achieve minimal deviation of optical output axis angle



### Longer distance fiber sensor heads

With built-in focal lenses the longer distance fiber heads provide enhanced operational stability in dusty environments or long distance applications

- Sensing distance up to 20 m
- Built-in focal lens
- Sizes from dia 2 mm to M14

### Ordering information

Sensor type	Size	Sensing distance (in mm) <sup>*1</sup>	Order code
	M14	20000	E32-T17L
	25,2x10.5x8 mm	3400	E32-T14
	M4	1330	E32-T11L 2M
	M3	680	E32-TC200A 2M
	dia 3 mm	1330	E32-T12L 2M
	dia 2 mm	440	E32-T22L 2M
	21.5x27x10 mm	1500 <sup>*2</sup>	E32-R16 2M
	22x17.5x9 mm	700	E32-D16 2M
	M6	400	E32-D11L 2M
	M4	130	E32-D21L 2M
	dia 3 mm	230	E32-D12 2M

<sup>\*1</sup> Sensing distance measured with E3X-DA-SE-S family. Longer sensing distance up to 80% can be achieved with E3X-DA-S.

<sup>\*2</sup> Measured with E39-R1

### Specifications

Item	Through-beam				Retro-reflective	Diffuse-reflective					
	E32-T17L/ E32-T14	E32-T11L/ E32-T12L	E32-TC200A	E32-T22L	E32-R16	E32-D16	E32-D11L	E32-D21L	E32-D12		
Permissible bending radius	R25				R10	R25	R4	R25	R10	R25	
Cut to length	Yes										
Ambient temperature	-40°C to 70°C										
Material	Head	ABS		Brass-nickel plated	Stainless steel	ABS	Aluminium	Brass-nickel plated	Stainless steel		
	Fiber	PMMA									
	Sheath	Polyethylene coating					PVC coating	Polyethylene coating			
Degree of protection	IEC 60529 IP67					IEC 60529 IP40	IEC 60529 IP67				

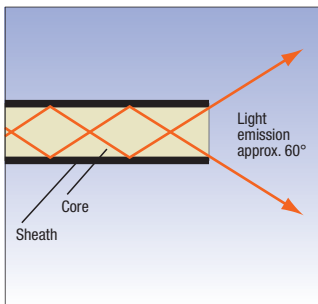

Light emission of conventional fibers

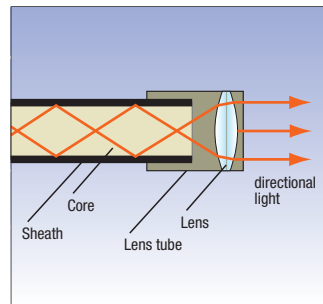

With built-in focal lenses, longer sensing distances can be achieved up to 5 times longer compared to conventional sensors





### Chemical resistant fiber sensor heads

The chemical resistant fibers provide long sensor lifetime in areas with frequent cleaning, usage of chemicals and higher temperatures.

- fluoroplastic cover for highest chemical resistance
- temperature resistance up to 200°C

#### Ordering information

Sensor type	Size	Sensing distance (in mm) <sup>*1</sup>	Key feature	Order code
	M4	680	Fluororesin coating	E32-T11U 2M
	dia 5 mm	500 3,000	Fluororesin cover	E32-ET11F 2M E32-T12F
	dia 5 mm	1,400	Fluororesin cover	E32-T14F 2M
	M6	170	Fluororesin coating	E32-D11U 2M
	dia 7 mm	80	Fluororesin cover	E32-ED11F 2M
	dia 6 mm	95	Fluororesin cover	E32-D12F
	dia 6 mm	40	Fluororesin cover	E32-D14F 2M
	dia 6 mm	700	Fluororesin cover Heat resistant to 200°C	E32-T81F-S 2M
	dia 5 mm	3,000	Fluororesin cover Heat resistant to 150°C	E32-T51F 2M

<sup>\*1</sup> Sensing distance measured with E3X-DA-SE-S family. Longer sensing distance up to 80% can be achieved with E3X-DA-S.

#### Specifications

Item	Fluororesin coating		Full fluororesin cover		Full fluororesin cover and heat resistance		
	E32-T11U	E32-D11U	E32-E_11F	E32-_12F/E32-_14F	E32-T51F	E32-T81F-S	
Permissible bending radius (in mm)	R1	R4	R75	R40		R10	
Cut to length	yes					no	
Ambient temperature	-40°C to 70°C					-40°C to 150°C	-40°C to 200°C
Material	Head	Brass-nickel plated		Fluororesin			
	Fiber	PMMA					Glass
	Sheath	Fluororesin coating		Fluororesin cover			
Degree of protection	IEC60529 IP67						

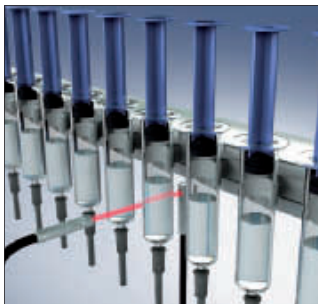

The fluororesin cover provides highest chemical resistance for longest lifetime in frequently cleaned environments like aseptic filling in pharmaceutical applications



Enhanced temperature resistant models



Highest chemical resistance



## Heat resistant fiber sensor heads

The wide range of heat resistant fibers provides long sensor lifetime with highest protection in demanding environments

- heat resistant up to 400°C
- sizes from dia 2 mm to M6
- models for long distances or high detection accuracy

### Ordering information

Sensor type	Size	Sensing distance (in mm) <sup>*1</sup>	Key feature	Order code	
				For E3X-DA-S teachable amplifier	for E3X-NA amplifier with potentiometer adjustment
	M4	450	-40°C to 150°C	E32-ET51 2M	
		425	-40°C to 100°C <sup>*2</sup> , high-flex	E32-T51R 2M	
		280	-40°C to 200°C	E32-T81R-S 2M	
		450	-60°C to 350°C	E32-T61-S 2M	
	dia 2 mm	230	-40°C to 150°C	E32-T54 2M	
	dia 3 mm	1300	-40°C to 200°C	E32-T84S-S 2M	
	M6	230	-40°C to 150°C	E32-ED51 2M	
		135	-40°C to 100°C <sup>*2</sup> , high-flex	E32-D51R 2M	
		280	-40°C to 200°C	E32-D81R-S 2M	E32-D81R 2M
		150	-60°C to 350°C	E32-D61-S 2M	E32-D61
	M4	60	-40°C to 400°C	E32-D73-S 2M	E32-D73
	23x20x9 mm	35	-40°C to 150°C	E32-A09H 2M	
	30x24x9 mm	25	-40°C to 300°C	E32-A09H2 2M	
	25x18x5 mm	5	-40 to 300°C	E32-L64 2M	
	36x18x5 mm	18		E32-L66 2M	

<sup>\*1</sup> Sensing distance measured with E3X-DA-SE-S family. Longer sensing distance up to 80% can be achieved with E3X-DA-S.

<sup>\*2</sup> Short term resistance. For continuous operation -40°C to 90°C

## Specifications

Item	-40°C to 150°C	-40°C to 100°C	-40°C to 150°C		-40°C to 200°C		-40°C to 300°C		-60°C to 350°C	-40°C to 400°C
	E32-E_51	E32-D51R/T51R	E32-T54	E32-A09H	E32-_81_	E32-T84_	E32-A09H2	E32-L6_	E32-_61_	E32-D73_
Permissible bending radius (in mm)	R35	R2	R35		R10	R25				
Cut to length	Yes					No				
Material	Head	Brass-nickel plated	Stainless steel		Aluminium	Stainless steel				
	Fiber	PMMA	Acrylate resin	PMMA		Glass				
	Sheath	Fluoro resin	Polyurethane resin	Fluoro resin		Stainless steel spiral coating	Stainless steel tube	Stainless steel spiral coating		Stainless steel tube
Degree of protection	IEC 60529 IP67	IEC 60529 IP50	IEC 60529 IP67							

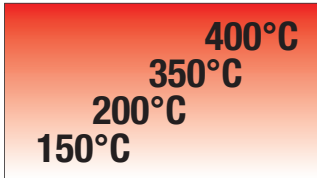

The temperature range optimised material selection provides best application fit and value - performance ratio.



Stainless steel spiral coating for flexibility with highest mechanical protection.





### Vacuum resistant fiber sensor heads

For applications in cleanest and hot environments the vacuum resistant fibers and connecting flanges provide long operational lifetime and vacuum integrity.

- Leakage rate of  $1 \times 10^{-10}$  Pa·m<sup>3</sup>/s max
- Heat resistance up to 200°C
- Detergent resistant fluororesin or stainless steel fiber sheath

### Ordering information

#### Sensor

Sensor type	Size	Sensing distance (in mm) <sup>*1</sup>	Temperature range	Order code
	M4	200	-40°C to 120°C	E32-T51V 1M
	dia 3	130	-40°C to 120°C	E32-T54V 1M
	dia 3	480	-60°C to 200°C	E32-T84SV 1M
	33x18x5.5 mm	5	-40°C to 70°C	E32-G86V-13M

<sup>\*1</sup> Sensing distance measured with E3X-DA-SE-S family. Longer sensing distance up to 80% can be achieved with E3X-DA-S.

#### Flange

Type	Size	Order code
4 channel flange	80x80x49 mm	E32-VF4
1 channel flange	96 x dia30 mm max.	E32-VF1
Flange-to-amplifier connection fiber	2 m length	E32-T10V 2M

### Specifications

Item	Fiber sensor heads				Flange-to-amplifier fiber
	E32-T51V	E32-T54V	E32-T84SV	E32-G86V-1	E32-T10V
Permissible bending radius	R30		R25		
Cut to length	No				Yes
Material	Head	Aluminium	Stainless steel		-
	Fiber	Glass			PMMA
	Sheath	Fluororesin coating		Stainless steel spiral coating	Polyethylene coating
Degree of protection	-				

Item	Flange	
	E32-VF1	E32-VF4
Leakage rate	1x10 <sup>-10</sup> Pa·m <sup>3</sup> /s max	
Ambient temperature	-25°C to 55°C	
Material	Flange	Aluminium and stainless steel / Aluminium
	Seal	Fluorocarbon rubber (viton)

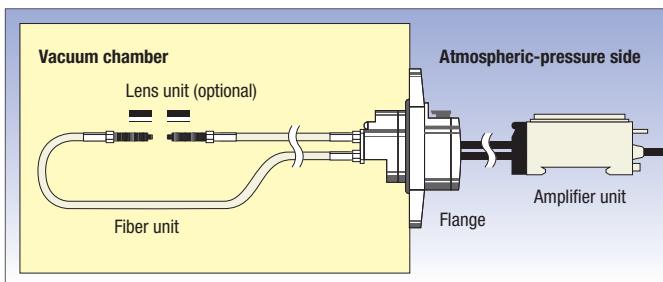

The vacuum resistant fiber heads and flanges are sealed to prevent gas leakage into vacuum areas



### Robot application fiber sensor heads

For applications on frequently or fast moving parts, the robot fibers reduce the risk of fiber breakage with a guaranteed operational life of more than 1 million bending cycles

- Free moving multicore fibers for > 1 mio bending cycles
- Square shapes for easy surface installation
- Cylindrical sizes from dia 1.5 mm to M6

### Ordering information

Sensor type	Size	Sensing distance (in mm) <sup>*1</sup>	Order code
	M4	680	E32-T11 2M
	M3	200	E32-T21 2M
	dia 3 mm	680	E32-T12B
	dia 2 mm	200	E32-T221B
	dia 1.5 mm	200	E32-T22B
	15x18x3 mm	680	E32-T15XB 2M
	M6	170	E32-D11 2M
	M4	70	E32-D21B 2M
	M3	30	E32-D21 2M
	dia 1.5 mm	30	E32-D22B 2M
	15x10x3 mm	170	E32-D15XB 2M

<sup>\*1</sup> Sensing distance measured with E3X-DA-SE-S family. Longer sensing distance up to 80% can be achieved with E3X-DA-S.

### Specifications

Item	Square		Cylindrical			
	E32-D15XB	E32-T15XB	E32-T21	E32-D11	E32-D21	E32-D21B
Permissible bending radius	R4					
Cut to length	Yes					
Material	Head	Aluminium	Brass-nickel plated			Stainless steel
	Fiber	PMMA				
	Sheath	PVC coating	Polyethylene coating	PVC coating		
Degree of protection	IEC 60529 IP67					

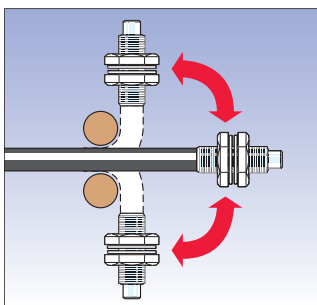

Guaranteed more than 1 mio bending operations

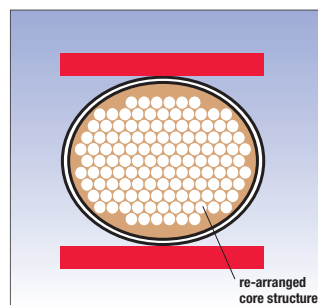
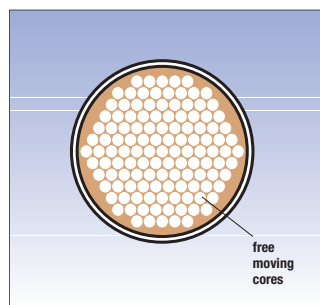

Free moving fiber cores prevent fiber breakage and light intensity loss when the fiber is bent.



## Precision detection fiber sensor heads

Highest precision in design and manufacturing of the fibers and focal lenses ensure highest beam and spot accuracy allowing the detection of smallest objects and height differences of less than 100 µm.

- Coaxial fibers with focal lenses for spot diameters of 100 µm
- Through-beam models with highly focused beam and precise optical axis alignment
- Limited reflective models for height difference detection of less than 100 µm

### Ordering information

Sensor type	Preferred usage	Size	Key feature	Sensing distance (in mm) <sup>*1</sup>	Order code
	Precise thin object detection / accurate positioning	dia 3 mm	<ul style="list-style-type: none"> <li>- High precision optical axis adjustment</li> <li>- Very focused beam</li> </ul>	1900	E32-T22S
				890	E32-A03 2M
		dia 2 mm		340	E32-A04 2M
   	Very small object detection	M6	–	300	E32-CC200 2M <sup>*2</sup>
		M3		Spot dia 0.5 mm	20
			Spot dia 0.2 mm	17	E32-EC41 1M + E39-F3B
			Spot dia 0.1 mm	7	E32-EC41 1M + E39-F3A-5
		dia 3 mm	–	150	E32-D32L
		dia 2 mm	–	75	E32-D32 2M <sup>*2</sup>
		M6	<ul style="list-style-type: none"> <li>- 90° cable exit</li> <li>- Hexagonal back</li> </ul>	170	E32-C11N 2M
		M3		25	E32-C31N 2M
			Small spot	8-25 m adjustable	E32-EC31 2M + E39-EF51
			Spot dia 0.7 to 3 mm	10 to 30 mm	E32-D32 2M + E39-F16
	Spot dia 0.3 to 1.6 mm		E32-C42 1M + E39-F16		
	Spot dia 0.5 to 1 mm	6-15 mm adjustable	E32-D32 2M + E39-F3A		
	Spot dia 0.1 to 0.6 mm	6-15 mm adjustable	E32-C42 1M + E39-F3A		
   	Precision height difference detection / flat surface detection	23x20x9 mm	–	35	E32-A09 2M
		16x18x4 mm	–	7.2	E32-L25L <sup>*2</sup>
		20x20x5 mm	–	3.3	E32-L25
		18x20x4 mm	Precise spot e.g. for detection of a flat / reflective surface	4	E32-L24L <sup>*2</sup>
		34x25x8 mm	High precision (detection accuracy 100 µm)	2.4	E32-EL24-1 2M
	Object detection in front of background	20.5x14x3.8 mm	Wide beam e.g. for object detection on a flat surface	15	E32-L16-N 2M

<sup>\*1</sup> Sensing distance measured with E3X-DA-SE-S family. Longer sensing distance up to 80% can be achieved with E3X-DA-S.

<sup>\*2</sup> A high flex cable version is available. Add 'R' to the order code, e.g. E32-CC200R



Specifications

Item	Through-beam			Diffuse reflective (coaxial)			Limited reflective				
	E32-T2S	E32-A03	E32-A04	E32-C11N E32-C31N	E32-CC200	E32-C42 E32-D32/-D32L E32-EC31/-EC41	E32-EL24-1	E32-L24L E32-L25L	E32-L25	E32-L16	E32-A09
Permissible bending radius	R10	R1	R10	R4	R25		R10		R25		
Cut to length	Yes										
Material Head	Brass-nickel plated		Stainless steel	Brass-nickel plated		Brass nickel plated	Brass-nickel plated and aluminium	Polycarbonate	ABS		Aluminium
Fiber	PMMA										
Sheath	PVC coating	Polyethylene coating		PVC coating	PVC, polyethylene and polyolefin coating		Polyethylene coating				
Degree of protection	IEC 60529 IP67		IEC 60529 IP50		IEC 60529 IP67			IEC 60529 IP50		IEC 60529 IP40	

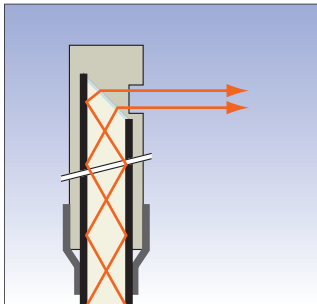

Focused and high precision beam alignment during manufacturing. Models available with typical deviation of 0.1° for very precise detections

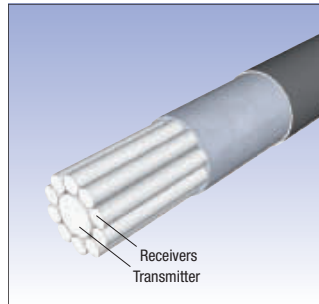

Coaxial fibers provide an enhanced positioning and detection accuracy and allow the easy adjustment of the focal point using adjustable focal lenses

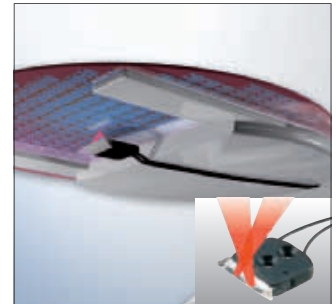
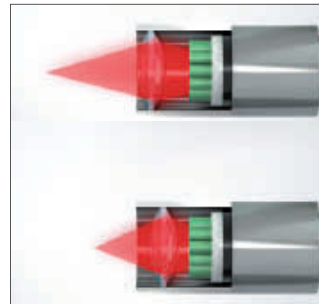

Limited reflective fibers utilize the total reflection on shiny surfaces to detect height differences or objects at a pre-defined distance.

### Area monitoring fiber sensor heads

The area monitoring fibers allow the detection of objects passing anywhere through the detection range and can be used for height comparisons of different objects.

- Area monitoring up to 70 mm height
- Multi-beam sensor with 4 separate heads for flexible detection points
- Standard or high flex fibers



### Ordering information

Sensor type	Area height (in mm)	Sensing distance (in mm) <sup>*1</sup>		Order code	
		Standard	High-flex	Standard	High-flex
	10	2800	–	E32-T16	–
<sup>*2</sup>	11	1100	840	E32-T16P	E32-T16PR 2M
	30	1800	1300	E32-T16W 2M	E32-T16WR 2M
	50	–	1800	–	E32-ET16WR-2 2M
	70	–	2000	–	E32-ET16WR-1 2M
	11	1000	750	E32-T16J 2M	E32-T16JR 2M
	4* separate M3 heads	610	–	E32-M21	–
	11	–	150	–	E32-D36P1 2M

<sup>\*1</sup> Sensing distance measured with E3X-DA-SE-S. Longer sensing distances up to 80% can be achieved with E3X-DA-S.

<sup>\*2</sup> Sensing area aligned to top of housing.

### Specifications

Item	Standard			High-flex			
	E32-T16	E32-M21	E32-T16J E32-T16P E32-T16W	E32-D36P1	E32-ET16WR-1 E32-ET16WR-2	E32-T16JR E32-T16PR E32-T16WR	
Permissible bending radius	R25			R10	R4	R1	
Cut to length	Yes						
Material	Head	ABS	Stainless steel	ABS	Brass-nickel plated	Aluminium	
	Fiber	PMMA					
	Sheath	Polyethylene coating			PVC coating	Polyethylene coating	
Degree of protection	IEC 60529 IP67			IEC 60529 IP50	IEC 60529 IP54		

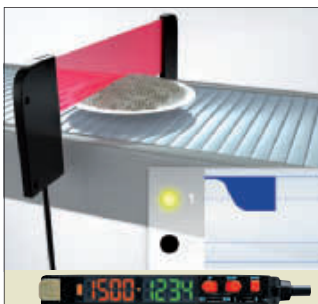

The two outputs of the E3X-DA-S can be used to detect two different light levels

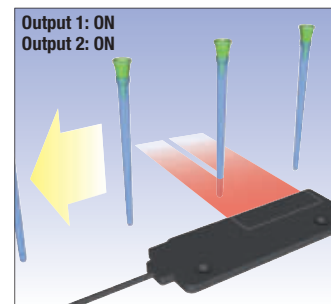
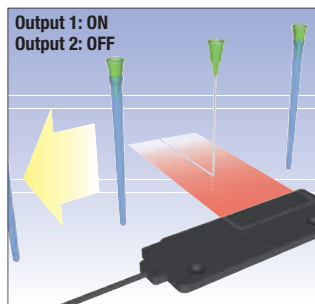

In combination with the twin output function of the E3X-DA-S amplifier, the diffuse reflective area monitoring fibers can detect very small objects (e.g. needles) and a second state (e.g. cover present). The area beam compensates for position variations at high speed.









## Special application fiber sensor heads

For a wide range of special applications, the task optimised fiber heads provide best fitting sensing performance and adaption to environmental requirements.

- Detection of special objects (liquids, labels on foils, etc.)
- Fiber heads ideal for colour mark detection
- Fiber heads optimised for special tasks (wafer mapping, flat glass, etc.)

### Ordering information

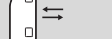
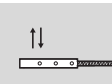
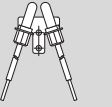
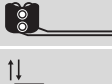
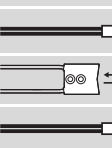
Sensor type		Size	Sensing distance (in mm) <sup>*1</sup>	Comment	Order code
	Fork shape	36x24x8 mm	10	–	E32-G14
	Wafer mapping	dia 3	1900	–	E32-T22S
		dia 3	1300	–	E32-T24S
		dia 3	890	–	E32-A03 2M
		dia 2	340	–	E32-A04 2M
	Liquid level sensor	dia 6	liquid contact	Liquid level contact	E32-D82F1 4M
		15x23.5x5 mm	tube contact	Liquid level detection through transparent tube or container	E32-D36T 2M
	Glass detection	21x16.5x4 mm	8 mm	Metal housing	E32-A10 2M
		20.5x14x3.8 mm	15 mm	Plastic housing	E32-L16-N 2M
	Glass detection in hot environment	25x18x5 mm	5 mm	Heat resistant up to 300°C	E32-L64 2M
		36x18x5.5 mm	18 mm		E32-L66 2M
	Glass detection in wet processes	38.5x39x17.5 mm	8 to 20 (recommended: 11 mm)	- Heat resistant up to 85°C - Recommended usage with 'tough mode' of E3X-DA-S	E32-L11FS 2M
	Label detection	20x20x5 mm	7.2	–	E32-L25L
		18x20x4 mm	4	–	E32-L24L
		34x25x8 mm	2.4	Very precise spot (detection accuracy 100 µm)	E32-EL24-1 2M
	Colour/print mark detection <sup>*2</sup>	M6	300	Recommended for standard colour and colour mark detection	E32-CC200 2M
		29x25.5x11.2	55	Recommended for challenging colour and colour mark detection	E32-L15 2M
		23x20x9 mm	35	Recommended for challenging colour and colour mark detection	E32-A09 2M
		M3	20	Recommended for very precise colour mark detection	E32-EC31 2M

<sup>\*1</sup> Sensing distance measured with E3X-DA-SE-S family. Longer sensing distance up to 80% can be achieved with E3X-DA-S.

<sup>\*2</sup> With amplifier E3X-DAC-S

Specifications

Item	E32-D82F1 E32-L11FS	E32-G14	E32-A09	E32-A10	E32-L15	E32-L16-N	E32-CC200	E32-EC31	E32-L66	E32-L64
Permissible bending radius	R40	R25								
Cut to length	Yes								No	
Material	Head	PFA	ABS	Aluminium	ABS	PAR	PVC	Brass-nickel plated	Stainless steel	
	Fiber	PMMA							Glass	
	Sheath	Polyethylene coating					PVC, polyethylene and polyolefin coating		Stainless steel spiral coating	
Degree of protection	IEC 60529 IP67		IEC 60529 IP40	IEC 60529 IP30	IEC 60529 IP50	IEC 60529 IP40	IEC 60529 IP67		IEC 60529 IP40	IEC 60529 IP50

Item	E32-EL24-1	E32-T24S	E32-L24L E32-L25L	E32-A04	E32-D36T	E32-A03	E32-T22S
Permissible bending radius	R10				R4	R1	
Cut to length	Yes						
Material	Head	Brass-nickel plated and aluminium	Stainless steel	Brass-nickel plated	Stainless steel	ABS	Brass-nickel plated
	Fiber	PMMA					
	Sheath	Polyethylene coating	PVC coating	Polyethylene coating		PVC coating	Polyethylene coating
Degree of protection	IEC 60529 IP67		IEC 60529 IP50		IEC 60529 IP67	IEC 60529 IP50	IEC 60529 IP67



In combination with the colour/mark detection amplifier E3X-DAC-S, the recommended fibers for colour/mark detection allow the detection of standard and challenging marks even for complex designs or with small contrast.

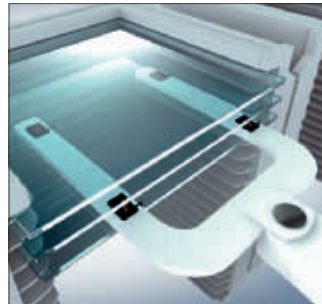

















The limited reflective fiber heads for glass detection provide a stable detection of flat glass in standard, hot or wet environment. The shapes and materials are optimized to provide the best value - performance ratio depending on the requirements.



For the detection of very small height differences like labels on foils in applications where space is crucial, the small sized limited reflective sensors provide accurate detection up to 100µm resolution.



## Accessories

Shape	Type	Comment	Order code
	Focal lens	- Extends sensing distance by more than 500% - For M4 Through beam fibers E32-TC200, E32-ET11R, E32-T11 (fits M2.6 thread) - 2 pcs per set	E39-F1
	Focal lens (side view)	- For M4 through beam fibers E32-TC200, E32-ET11R, E32-T11, E32-T61-S, E32-T81R-S (fits M2.6 thread) - Temperature range -40°C to +200°C - 2 pcs per set	E39-F2
	Focal lens (variable)	- For precision detection with E32-D32, EC41	E39-F3A E39-F16
	Focal lens	- For precision detection with E32-EC41	E39-F3A-5
	Focal lens	- For precision detection with E32-EC41	E39-F3B
	Focal lens	- For precision detection with M6 coaxial diffuse reflective fibers (e.g. E32-CC200)	E39-F18
	Focal lens (side view, variable)	- For precision detection with E32-EC31	E39-EF51
	Focal lens (heat resistant)	- Extends sensing distance by more than 500% - For M4 through beam fibers E32-ET51, E32-T61, E32-T61-S, E32-T81R, E32-T81R-S (fits M4 thread) - Temperature range -60°C to +350°C - 2 pcs per set	E39-EF1-37-2
	Focal lens (vacuum resistant, heat resistant)	- Fits E32-T51V and E32-T54V (fits M2.6 thread) - 2 units per set - Heat resistant up to 120°C	E39-F1V
	Fiber cutter	- Included in applicable fiber	E39-F4
	Thin fiber attachment	- Amplifier adapter for thin fibers - Included in applicable fiber (2 sets)	E39-F9
	Sleeve bender	- For E32-TC200B(4) - For E32-TC200F(4) - For E32-DC200F(4)	E39-F11
	Single fiber extension connector	- Fiber extension connector for 2.2 mm dia standard fibers - One unit	E39-F10
	Dual fiber extension connector	- For fibers with dia 2.2	E39-F13
		- For fiber with dia 1.0	E39-F14
		- For fibers with dia between 1.0 and 2.2	E39-F15
	Protective spiral tube <sup>*1</sup>	- For M3 diffuse type sensors - Length 1 m	E39-F32A
		- For M3 through beam type sensors - Length 1 m	E39-F32B
		- For M4 through beam type sensors - Length 1 m	E39-F32C
		- For M6 diffuse type sensors - Length 1 m	E39-F32D
	Fiber on roll <sup>*2</sup>	- Dia 2.2 mm - Standard monocoire, 10 mm bending radius - -40°C to 80°C	E32-E01 100M
		- Dia 1.1 mm - Standard monocoire, 15 mm bending radius - -40°C to 80°C	E32-E02 100M
		- Dia 2.2 mm - High flex multicore, 1 mm bending radius - -40°C to 80°C	E32-E01R 100M
		- Dia 1.1 mm - High flex multicore, 1 mm bending radius - -40°C to 80°C	E32-E02R 100M
		- Dia 2.2 mm - High temperature monocoire, 20 mm bending radius - -60°C to 150°C	E32-E05 100M

<sup>\*1</sup> Protective spiral tubes with 0.5 m length are available. Add '5' to order code...e.g. E39-F32A5

<sup>\*2</sup> Fiber length 100 m on a roll - cut to length



### Easy-teach digital fiber amplifier

E3X-DA-SE-S and E3X-SD allow easy one button setting and provide the best value performance ratio for standard applications.

- Auto-teaching during machine operation
- Object or 2-point teaching within a few seconds
- Simple threshold adjustment with up/down keys
- Digital double display for incident level and threshold (E3X-DA-SE-S) or reduced size with one display (E3X-SD)

### Ordering information

Item	Order code		Order code	
	Double display		Single display	
	NPN output	PNP output	NPN output	PNP output
Pre-wired	E3X-DA11SE-S 2M	E3X-DA41SE-S 2M	E3X-SD21	E3X-SD51
Fiber amplifier connector <sup>*1</sup>	E3X-DA6SE-S	E3X-DA8SE-S	E3X-SD7	E3X-SD9

\*1 Order connector separately. For M8 connector models see E3X-DA-S.

### Specifications

Item	E3X-DA-SE-S	E3X-SD
Light source (wave length)	Red LED (650 nm)	Red, 4-element LED (625 nm)
Power supply voltage	12 to 24 VDC ±10%, ripple (p-p): 10% max.	
Protective circuits	Power supply reverse polarity protection, output short-circuit protection, mutual interference prevention	
Response time	Operation or reset: 1 ms	Operation or reset: 200 µs max
Sensitivity setting	Teaching and digital up/down keys	
Functions	Auto power control	High-speed control method for emission current
	Mutual interference prevention	Optical communications sync, possible for up to 10 units
Digital displays	Incident level + threshold	Optical communication sync. possible for up to 5 units Incident level or threshold
Degree of protection	IEC 60529 IP50 (with protective cover attached)	

### Fiber amplifier connectors

Shape	Type	Comment	Order code
	Fiber amplifier connector	2 m PVC cable	E3X-CN21
		30 cm PVC cable with M12 plug connector (4 pin)	E3X-CN21-M1J 0.3M
		30 cm PVC cable with M8 plug connector (4 pin)	E3X-CN21-M3J-2 0.3M

### Easy view double display (E3X-DA-SE-S)

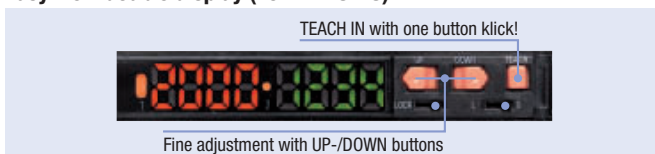

### Space saving single display (E3X-SD)



### 1-button auto-teaching

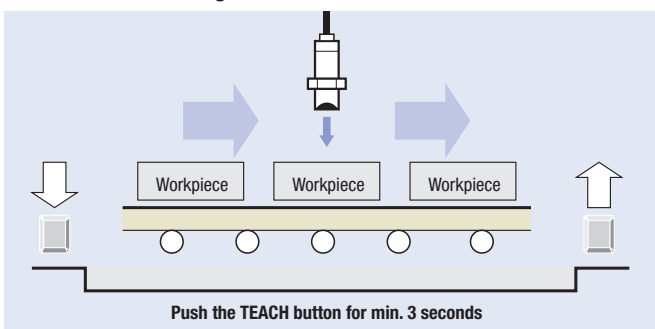

### 2-point teaching

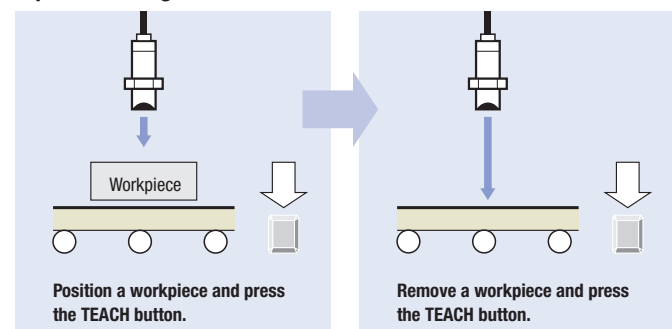

## Digital fiber amplifier with potentiometer adjustment



The E3X-NA is the ideal amplifier for standard fiber applications providing quick & easy potentiometer adjustment and bargraph display.

- Easy adjustment with potentiometer
- Mutual interference prevention
- Enhanced water resistance types

### Ordering information

#### Pre-wired

Item	Order code (for pre-wired types with 2 m cable length)	
	NPN output	PNP output
Standard	E3X-NA11 2M	E3X-NA41 2M
Enhanced water resistance	E3X-NA11V 2M	E3X-NA41V 2M

#### Connector version

Item	Order code	
	NPN output	PNP output
Standard (fiber amplifier connector)*1	E3X-NA6	E3X-NA8
Enhanced water resistance (M8 4-pin connector)	E3X-NA14V	E3X-NA44V

\*1 Order connector separately.

### Specifications

Item	Standard	Enhanced water resistance
Output	NPN output	E3X-NA11, E3X-NA6
	PNP output	E3X-NA41, E3X-NA8
Light source (wave length)	Red LED (625 nm)	
Power supply voltage	12 to 24 VDC $\pm 10\%$ , ripple (p-p): 10% max.	
Protective circuit	Reverse polarity protection, output short-circuit protection, mutual interference prevention	
Response time	Operation or reset: 200 $\mu$ s max.	
Sensitivity setting	8-turn endless adjuster (potentiometer)	
Functions	OFF-delay timer: 40 ms (fixed)	
Degree of protection	IEC 60529 IP50 (with protective cover attached)	IEC 60529 IP66 (with protective cover attached)

#### Fiber amplifier connectors

Shape	Type	Comment	Order code
	Fiber amplifier connector	2 m PVC cable	E3X-CN21
		30 cm PVC cable with M12 plug connector (4 pin)	E3X-CN21-M1J 0.3M
		30 cm PVC cable with M8 plug connector (4 pin)	E3X-CN21-M3J-2 0.3M



Bargraph display with light level, switching status and threshold indicators

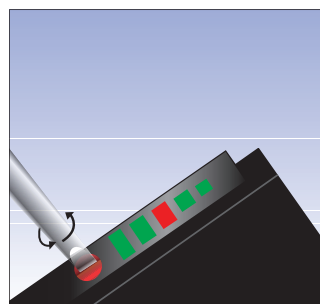

Simple sensitivity adjustment by potentiometer

### High functionality digital fiber amplifier



High functionality digital fiber amplifier with advanced timing, LED power control and signal processing functionality providing highest detection accuracy and stability even for the most challenging objects and settings.

- Power tuning function to adjust the received light to a maximum, minimum or pre-defined value
- Auto power and threshold adjustment functions for highest operational stability
- Two outputs for window monitoring or two level detections (e.g. object + object state change)

#### Ordering information

Item	Function								Order code	
	Power tuning	Timer	Auto-threshold compensation (ATC)	Twin output	External input	Differential operation	Wet process 'tough mode'	Power saving 'Eco' functions (display/LED off)	NPN	PNP
Pre-wired	Yes	Yes	Yes	Yes	Yes	Yes	Yes	Yes	E3X-DA21-S 2M	E3X-DA51-S 2M
Fiber amplifier connector*1	Yes	Yes	Yes	Yes - selectable		Yes	Yes	Yes	E3X-DA7-S	E3X-DA9-S
M8 connector	3 pin	Yes	Yes	*2					E3X-DA13-S	E3X-DA43-S
	4 pin								E3X-DA14-S	E3X-DA44-S

\*1 Order fiber amplifier connector E3X-CN\_ separately

\*2 For fiber amplifiers with these functions and connecting with M8 connector, contact your OMRON representative.



#### Specifications

Item	Pre-wired models		Fiber amplifier connector models		M8 connector models	
	E3X-DA_1-S		E3X-DA7-S, E3X-DA9-S		E3X-DA_3-S, E3X-DA_4-S	
Light source (wave length)	Red LED (650 nm)				Red LED (625 nm)	
Power supply voltage	12 to 24 VDC ± 10%; ripple (p-p): 10% max					
Protective circuits	Reverse polarity protection, output short circuit protection, mutual interference prevention*1					
Response time	Super-high-speed mode	80 µs for operation and reset max.				55 µs for operation and reset max.
	Standard mode	1 ms for operation and reset				
	High resolution mode	4 ms for operation and reset				
	Wet process 'tough mode'	16 ms for operation and reset				*2
Sensitivity setting	Teaching and digital up/down keys					
Functions	Power tuning	Light emission power and reception gain, digital control method				
	Timer	OFF-delay, ON-delay, one-shot timer. 1 ms to 5 s (1 to 20 ms set in 1-ms increments, 20 to 200 ms set in 10-ms increments, 200 ms to 1 s set in 100-ms increments, and 1 to 5 s set in 1 s-increments)				
	Auto power control (APC)	LED power monitoring and auto-control function by LED emission current adjustment.				
	Active-threshold control (ATC)	Monitoring of received light average and deviation adjustment of threshold for output 1				*2
	Twin output	Output 1: incident level Output 2: incident level or alarm output		Output 1: incident level Output 2: incident level or alarm output (not available if external input is used)		*2
	External input	External teach or function trigger (power tuning, emitter OFF, ATC start)		External teach or function trigger (power tuning, emitter OFF, ATC start) (not available if output 2 is used)		*2
	Differential operation	Single edge or double edge detection mode				*2
	Wet process 'tough mode'	Incident level triggering on floating average of received light.				*2
Power saving 'Eco' functions	LED: ON/OFF switchable (external input)					*2
	Display: ON/ DIM / OFF selectable					
Digital display	Incident level + threshold or user specific					
Degree of protection	IEC 60529 IP50 (with protective cover attached)					

\*1 The reverse polarity protection for the pre-wired and fiber amplifier connector models is for the power supply and the output. For M8 connector models the reverse polarity protection is for the power supply.

\*2 For fiber amplifiers with these functions and connecting with M8 connector, contact your OMRON representative.

## Fiber amplifier connectors

Shape	Type	Comment	Order code
	Fiber amplifier connector	2 m PVC cable	E3X-CN21
		30 cm PVC cable with M12 plug connector (4 pin)	E3X-CN21-M1J 0.3M
		30 cm PVC cable with M8 plug connector (4 pin)	E3X-CN21-M3J-2 0.3M

## Power tuning



Increase or decrease the LED power and received light intensity to the desired level e.g. a pre-defined value for easy sensor malfunction detection.

## Light coupling

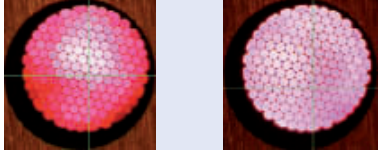

Light distribution in multi-core-fibers with conventional fiber amplifiers

Light distribution in the new E3X-DA-S amplifier generation

## Timer functions

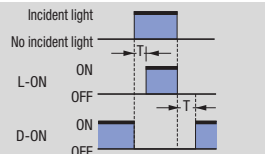
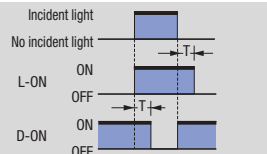
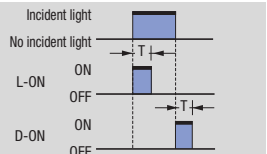
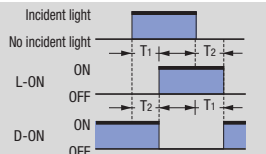
ON delay	OFF delay	One-shot	ON delay and OFF delay
			

$T_1$ : ON-delay set time  
 $T_2$ : OFF-delay set time  
 $T_1$  and  $T_2$  can be set separately.

Adjust the output signal length and timing

## Twin output



The two outputs can be used to detect two different light levels

## Differential detection

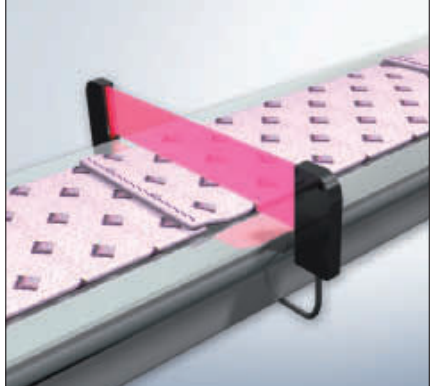

Triggering on single or double signal edges

## Active-threshold control (ATC)

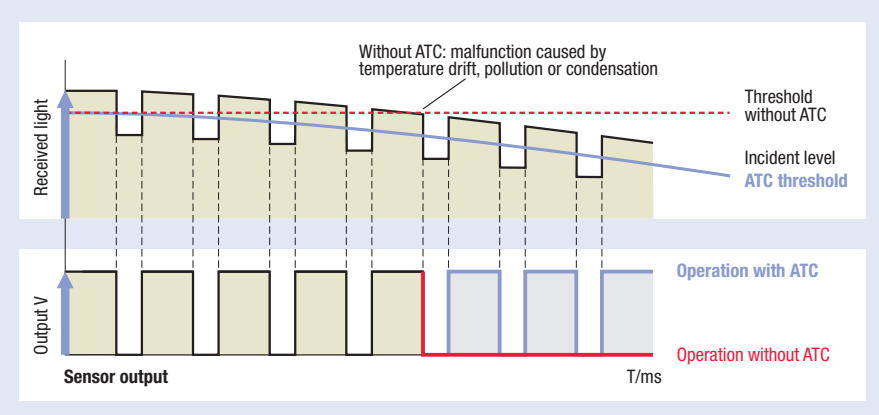

Without ATC: malfunction caused by temperature drift, pollution or condensation

Threshold without ATC

Incident level

ATC threshold

Operation with ATC

Operation without ATC

Sensor output

T/ms

Higher signal stability compensating for power reduction caused by temperature drift, dust or condensation.



## 2-in-1 Digital fiber amplifier



E3X-MDA incorporates 2 digital fiber amplifiers in one slimline housing. For applications requiring the detection of two objects simultaneously the E3X-MDA provides an easy to use operation saving space and set-up time.

- Two digital amplifiers in one slimline housing
- Twin output models – on/off or area (between two threshold values)
- Signal comparison functions (AND, OR, etc.)

### Ordering information

Item	Functions	Order code	
		NPN output	PNP output
Pre-wired	AND/OR output	E3X-MDA11	E3X-MDA41
Fiber amplifier connector <sup>*1</sup>	AND/OR output	E3X-MDA6	E3X-MDA8

<sup>\*1</sup> Order connector separately.

### Specifications

Item	E3X-MDA
Light source (wave length)	Red LED (650 nm)
Power supply voltage	12 to 24 VDC ±10%, ripple (p-p) 10% max.
Protective circuits	Power supply reverse polarity protection, output short-circuit protection, mutual interference prevention
Response time	Super-high-speed mode
	Standard mode
	High-resolution mode
Sensitivity setting	Teaching and digital up/down keys
Functions	Power tuning
	Timer function
	I/O settings
Digital displays	Select from the following: Incident level for channel 1 + incident level for channel 2, Incident level + threshold, incident level percentage + threshold, incident light peak level + no incident light bottom level, minimum incident light peak level + maximum no incident light bottom level, long bar display, incident level + peak hold, incident level + channel
Degree of protection	IEC 60529 IP50 (with protective cover attached)

### Fiber amplifier connectors

Shape	Type	Comment	Order code
	Fiber amplifier connector	2 m PVC cable	E3X-CN21
		30 cm PVC cable with M12 plug connector (4 pin)	E3X-CN21-M1J 0.3M
		30 cm PVC cable with M8 plug connector (4 pin)	E3X-CN21-M3J-2 0.3M

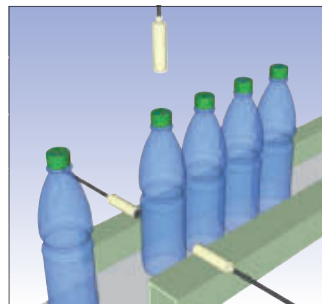

The AND and OR functionality for the two fiber channels allows simple signal processing without the need for a PLC. This allows the addition of sensor checks to machines without reprogramming the PLC.

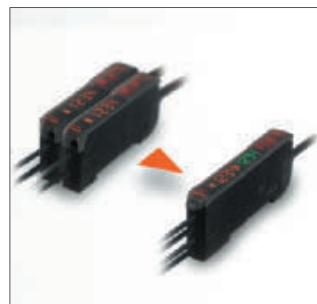

The 2 in 1 amplifier replaces two standard amplifiers reducing space requirements and hardware cost.



## Fast response digital amplifier with potentiometer

The E3X-NA\_F provides a very fast response time and is the ideal amplifier for high speed detection applications.

- Short turn on time of only 20  $\mu$ s
- Easy adjustment with potentiometer

### Ordering information

Item	Order code	
	NPN output	PNP output
Pre-wired	E3X-NA11F	E3X-NA41F
M8 connector (4 pin)	-*1	E3X-NA44FV

\*1 Contact your OMRON representative

### Specifications

Item	NPN output	E3X-NA11F	-
	PNP output	E3X-NA41F	E3X-NA44FV
Light source (wave length)	Red LED (680 nm)		
Power supply voltage	12 to 24 VDC $\pm$ 10%, ripple (p-p): 10% max.		
Protective circuit	Reverse polarity protection, output short-circuit protection, mutual interference prevention		
Response time	Operation: 20 $\mu$ s max. Reset: 30 $\mu$ s max.		
Sensitivity adjustment	8-turn endless adjuster (potentiometer)		
Functions	OFF-delay timer: 40 ms (fixed)		
Degree of protection	IEC 60529 IP50 (with protective cover attached)		IEC 60529 IP66 (with protective cover attached)

Note: For teachable fast response fiber amplifiers with a digital display contact your OMRON representative.



## E3X-DAC-S colour (RGB) digital fiber amplifier

The E3X-DAC-S detects the colour and returned light intensity of a mark or object and compares it with a stored RGB ratio or intensity value. The RGB ratio or contrast difference allows the stable detection of differently coloured, black, grey or white marks or objects.

- White LED for colour independence
- Fast response time of min. 60  $\mu$ s
- Timer function for variable ON or OFF delay up to 5 s
- Remote teaching or easy one-button teaching

### Ordering information

#### Pre-wired

Item	Functions	Order code (for pre-wired types with 2 m cable length)	
		NPN output	PNP output
Standard models	Timer, response speed change	E3X-DAC11-S	E3X-DAC41-S
Advanced models	Standard models + simultaneous determination (2 colours) AND/OR output, remote setting	E3X-DAC21-S	E3X-DAC51-S

#### Connector versions



Item	Functions	Order code	
		NPN output	PNP output
Standard models (fiber amplifier connector) <sup>*1</sup>	Timer, response speed change	E3X-DAC6-S	E3X-DAC8-S

<sup>\*1</sup> Order connector separately

### Specifications

Item	Standard models E3X-DAC1, E3X-DAC4 E3X-DAC6, E3X-DAC8	Advanced models E3X-DAC2, E3X-DAC5
Light source (wave length)	White LED (420 to 700 nm)	
Number of registered colours	1	2 (simultaneous determination)
Power supply voltage	12 to 24 VDC $\pm$ 10%, ripple (p-p) 10% max.	
Protective circuits	Power supply reverse polarity protection, output short circuit protection, output reverse polarity protection, mutual interference prevention	
Response time	<b>Super-high-speed mode</b> Operation or reset: 60 $\mu$ s <b>High-speed mode</b> Operation or reset: 300 $\mu$ s <b>Standard mode</b> Operation or reset: 1 ms <b>High-resolution mode</b> Operation or reset: 4 ms	Operation or reset: 120 $\mu$ s Operation or reset: 600 $\mu$ s Operation or reset: 2 ms Operation or reset: 8 ms
Sensitivity setting (colour registration, allowable range)	Teaching (one-point teaching or teaching with/without workpiece) or manual adjustment	
Functions	Detection mode	Automode (automatic selection of C-mode or I-mode) C-mode (RGB ratio) I-mode (light intensity) Mark mode (Intensity and ratio of RGB values)
	Operating mode	ON for match (ON for same colour as registered colour) or ON for mismatch (ON for different colour from registered colour)
	Timer function	Timer type: OFF delay, ON delay, or one-short Timer time: 1 ms to 5 s (variable)
	Control outputs	–
	Remote control	–
Degree of protection	IEC60529 IP50 (with protective cover attached)	

## Fiber amplifier connectors

Shape	Type	Comment	Order code
	Fiber amplifier connector	2 m PVC cable	E3X-CN21
		30 cm PVC cable with M12 plug connector (4 pin)	E3X-CN21-M1J 0.3M
		30 cm PVC cable with M8 plug connector (4 pin)	E3X-CN21-M3J-2 0.3M



Detection of differently coloured objects or marks by RGB ratio comparison.



Contrast detection by returned light intensity comparison.



Easy to operate detection of coloured marks or objects (1 or 2 per amplifier). The scalability allows multi-colour identification e.g. for sorting applications with high cost efficiency compared to conventional colour sensors.



Detection of challenging marks

## Digital fiber amplifier with infrared LED

The digital fiber amplifiers with infrared LED are ideal for water detection applications or where visible light is not desired.

- Infrared LED
- LED power control and signal processing function



### Ordering information

#### Pre-wired

Item	Order code (for pre-wired types with 2 m cable length)	
	NPN output	PNP output
Infrared light	E3X-DAH11-S 2M	E3X-DAH41-S 2M

#### Connector version

Item	Order code	
	NPN output	PNP output
Infrared light (fiber amplifier connector)*1	E3X-DAH6-S	E3X-DAH8-S

\*1 Order connector separately

### Specifications

#### Amplifier units with cables

Item	NPN output	E3X-DAH11-S, E3X-DAH6-S	
	PNP output	E3X-DAH41-S, E3X-DAH8-S	
Light source (wave length)	Infrared LED		
Power supply voltage	12 to 24 VDC $\pm$ 10%, ripple (p-p) 10% max.		
Protective circuits	Power supply reverse polarity protection, output short circuit protection, mutual interference prevention		
Response time	Super-high-speed mode	NPN	48 $\mu$ s for operation and 50 $\mu$ s for reset
		PNP	53 $\mu$ s for operation and 55 $\mu$ s for reset
	Standard mode		1 ms for operation and reset respectively
	High-resolution mode		4 ms for operation and reset respectively
Sensitivity setting	Teaching and digital up/down keys		
Functions	Power tuning	Light emission power and reception gain, digital control method	
	Timer function	Select from OFF-delay, ON-delay, or one-shot timer. 1 ms to 5 s (1 to 20 ms set in 1-ms increments, 20 to 200 ms set in 10-ms increments, 200 ms to 1 s set in 100-ms increments, and 1 to 5 s set in 1 s-increments)	
Digital displays	Incident level + threshold or user specific		
Degree of protection	IEC 60529 IP50 (with protective cover attached)		

#### Fiber amplifier connectors

Shape	Type	Comment	Order code
	Fiber amplifier connector	2 m PVC cable	E3X-CN21
		30 cm PVC cable with M12 plug connector (4 pin)	E3X-CN21-M1J 0.3M
		30 cm PVC cable with M8 plug connector (4 pin)	E3X-CN21-M3J-2 0.3M

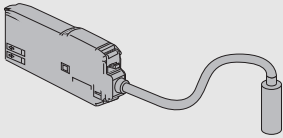
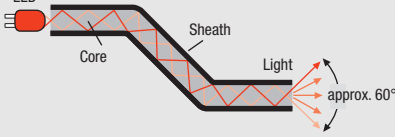
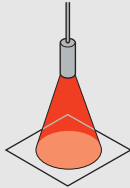
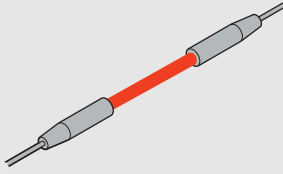
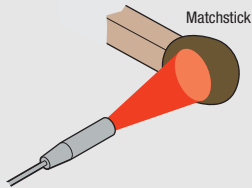
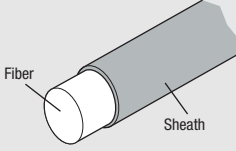
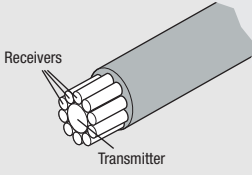
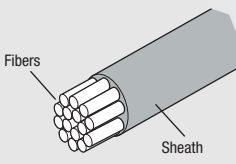

## Fiber optics

Item		
Principle of operation		<p>Fiber optic photoelectric sensors comprise two parts, the amplifier and the sensing head. The amplifier contains the emitter (the light source) and receiver (detector) along with their associated electronics. The fiber optic cable is the means used to transfer the light to the sensing head.</p>
		<p>The light source (an LED) transmits the light beam down the fiber optic cable by repeatedly reflecting the light off the boundary between the fiber core and its sheath. When it reaches the end of the fiber the light is dispersed at the end.</p>
		<p>When the light is dispersed it spreads out and forms a beam much like that of other sensors, but on a smaller scale. With smaller light sources and lens areas the sensing ranges are on the whole much shorter.</p>
Types of fiber		<p>Fiber optic heads mainly split into two types, through-beam and diffuse (although there are a few retro-reflective types). The principle of operation of both types is exactly that of standard photoelectric sensors.</p>
		
Construction		<p>Standard fiber: Most fiber optic sensing heads use this configuration of fiber (i.e. a single fiber covered by a protective sheath). The fibers are usually plastic, 0.5 to 1 mm in diameter and covered in a plastic protective sheath.</p>
		<p>Coaxial fiber: This gives greater accuracy. The core is used as the transmitter and the surrounding fibers are bundled together to form the receiver. This gives better accuracy, the target can enter the detecting area from any direction.</p>
		<p>Multicore: These consist of large numbers of small fibers. This results in a more flexible cable (E32-R types) which can literally be tied in a knot.                      Robotic: In robotic fibers the multicore fibers are manufactured without fixation. This allows them to move freely reducing mechanical stress when the fiber is bent.</p>

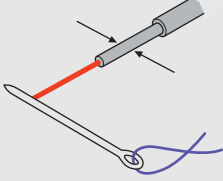
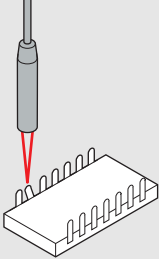
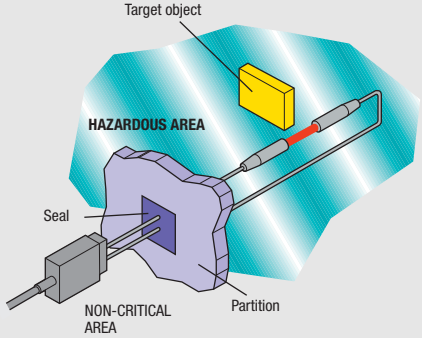
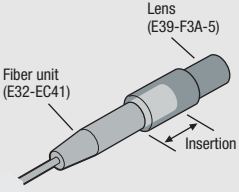
Item		
Using fiber optic sensors		<p>The main advantage of fiber optics is that they are small. This means that they can be mounted in places where other sensors couldn't fit.</p>
		<p>As the sensor heads are extremely compact, they are ideal for the stable detection of small objects. As a result of the less light that is emitted they generally do have smaller ranges than conventional photoelectric sensors.</p>
		<p>Fiber optic sensor heads can be used in areas that standard sensors are unable to go, for instance hazardous areas. This is because no electric current flows through them. This also means they are totally unaffected by electrical noise (provided the amplifier is suitably positioned). By using glass fibers instead of plastic they can be used in areas of up to 350°C.</p>
		<p>Extremely small objects can be detected with a diffuse coaxial sensor and additional focal lens. Using these, objects as small as 100 µm can be detected.</p>

# Product dimensions

## E32-A03

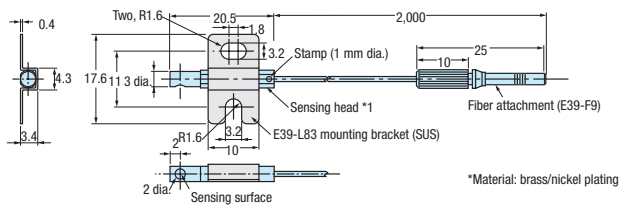

## E32-A03-1

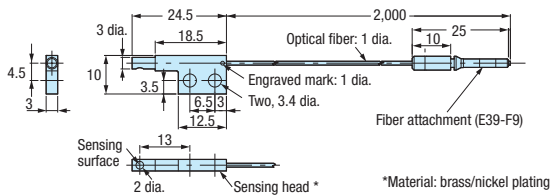

## E32-A04

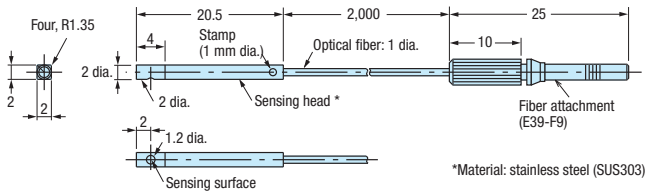

## E32-A04-1

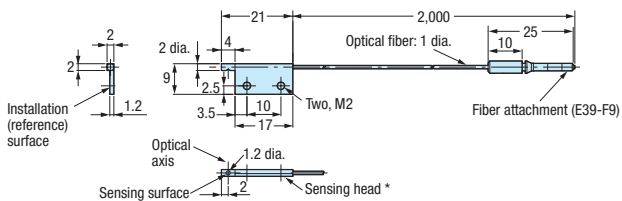

## E32-A09, E32-A09H

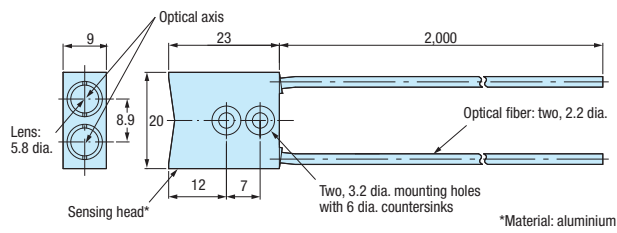

## E32-A09H2

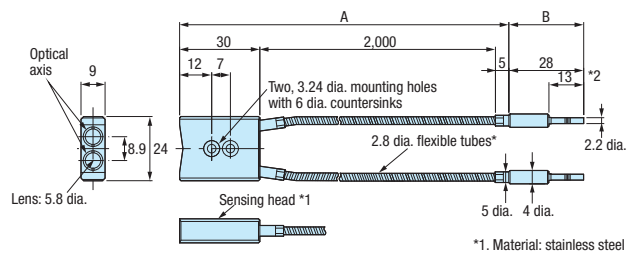

## E32-A10

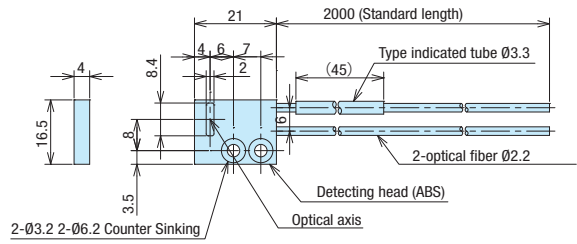

## E32-C11N

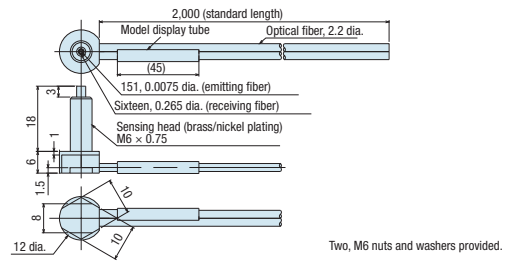

## E32-C31N

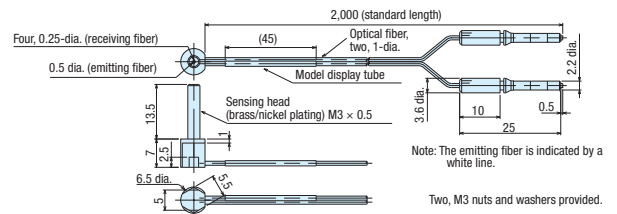

## E32-C42

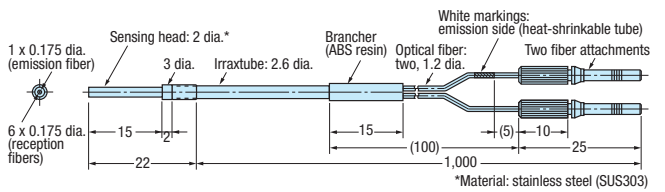

## E32-CC200

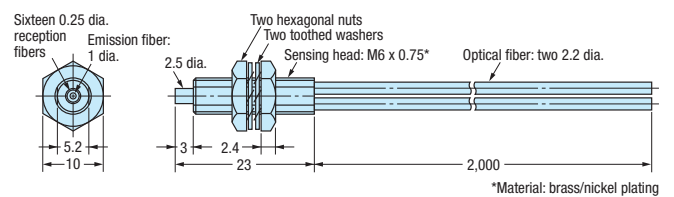

## E32-D11, E32-D11U

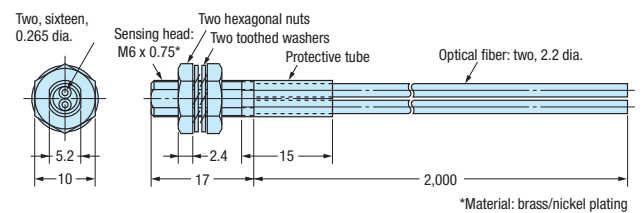

# Product dimensions

## E32-D11L

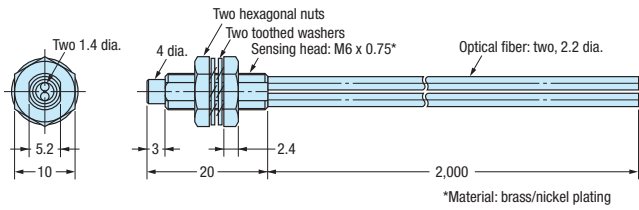

## E32-D11N

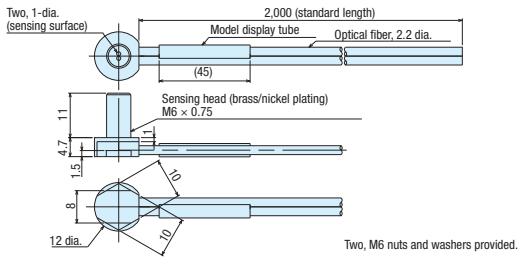

## E32-D12

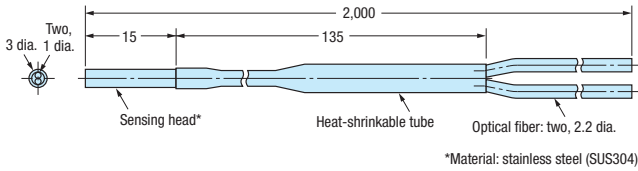

## E32-D12F

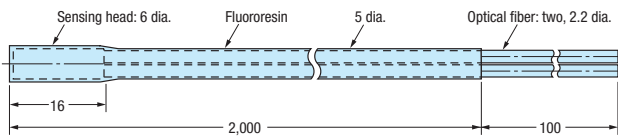

## E32-D14F

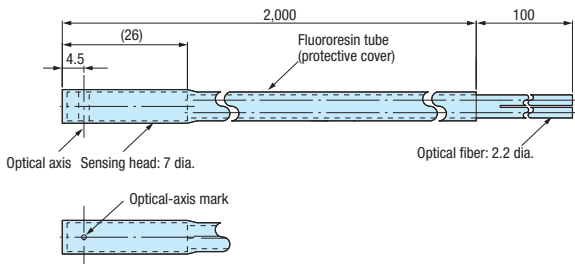

## E32-D14L, E32-D14LR

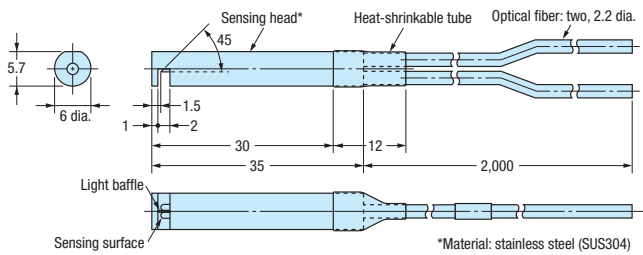

## E32-D15X, E32-D15XB, E32-D15XR

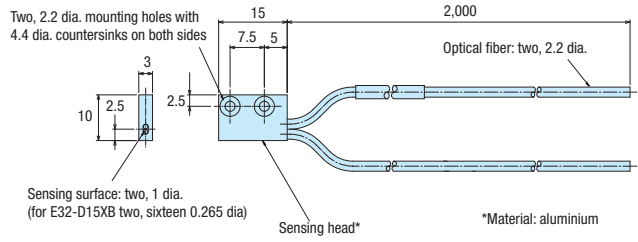

## E32-D15Y, E32-D15YR

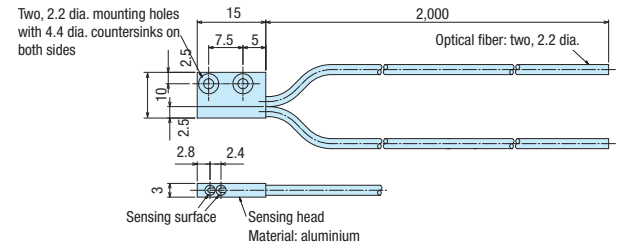

## E32-D15Z

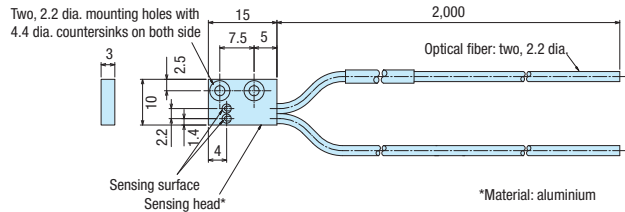

## E32-D16

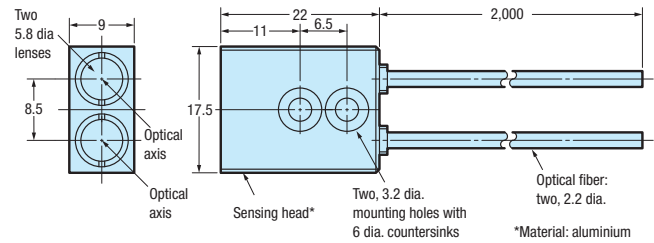

## E32-D21

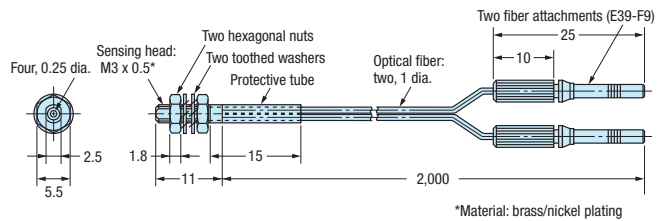

## E32-D21B

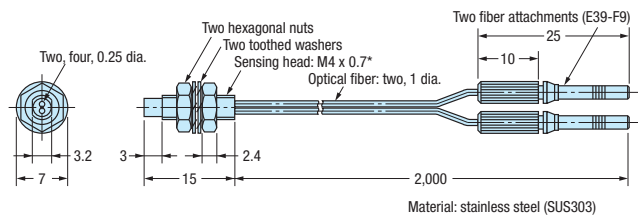

# Product dimensions

## E32-D21L

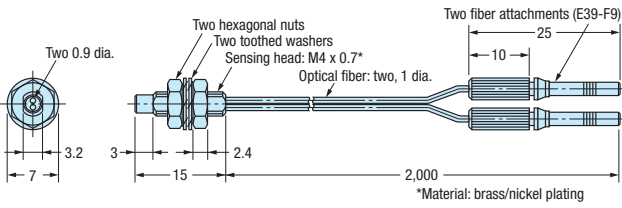

## E32-D22, E32-D22R

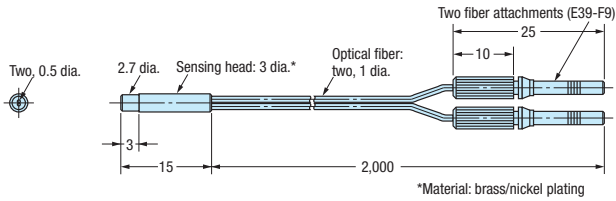

## E32-D22B

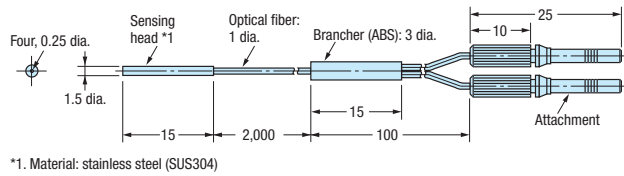

## E32-D24, E32-D24R

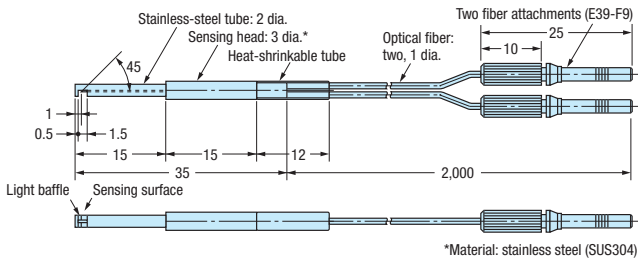

## E32-D32 / E32-D32R

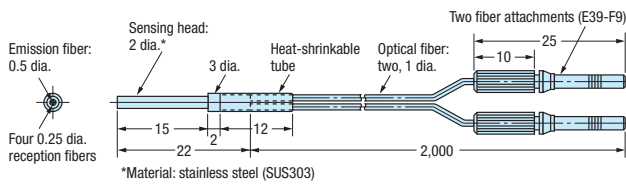

## E32-D32L

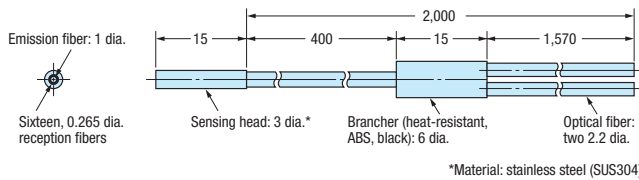

## E32-D33

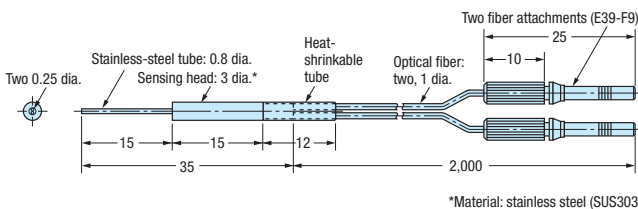

## E32-D36P1

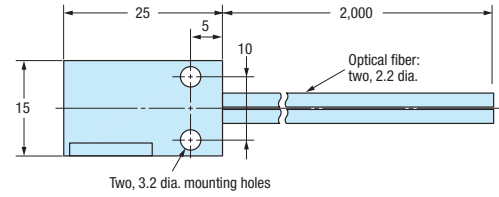

## E32-D36T

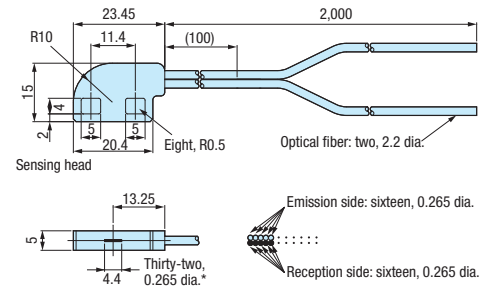

## E32-D51R

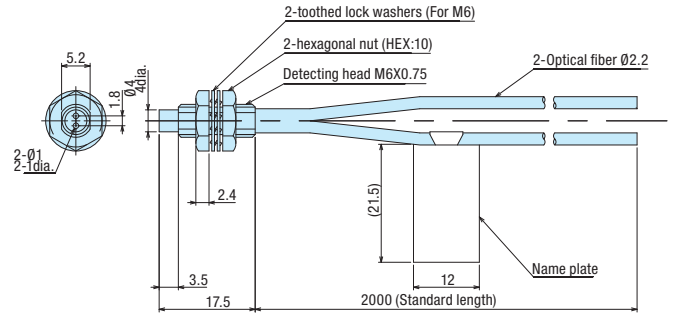

## E32-D61-S, E32-D61

### Using the E32-D61-S

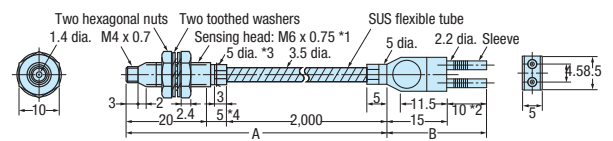

### Using the E32-D61

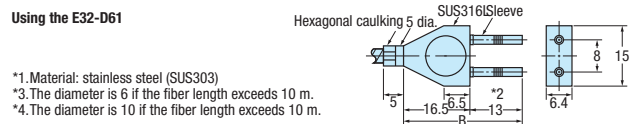

## E32-D73-S, E32-D73

### Using the E32-D73-S

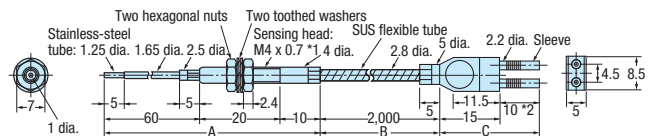

### Using the E32-D73

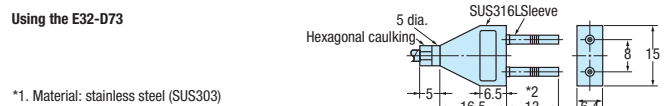



# Product dimensions

## E32-D81R-S, E32-D81R

### Using the E32-D81R-S

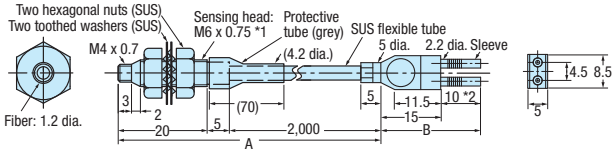

### Using the E32-D81R

\*1. Material: stainless steel (SUS303)

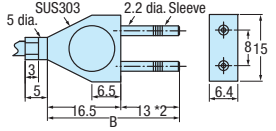

## E32-D82F1

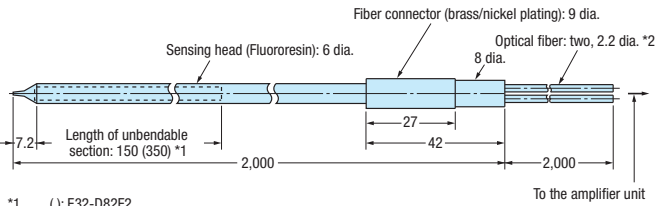

\*1. (.) E32-D82F2  
\*2. The 2-m section of optical fiber on the amplifier unit side is plastic and therefore allows free cutting.

## E32-D211, E32-D211R

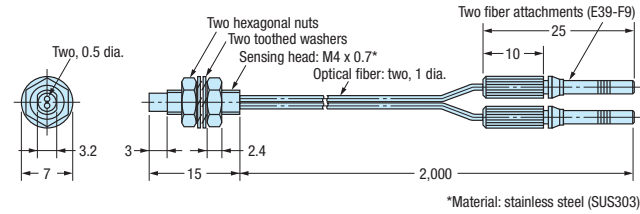

## E32-D331

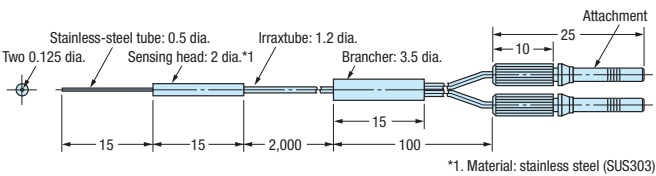

## E32-DC200

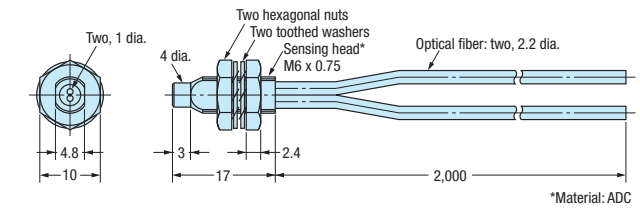

## E32-DC200B, E32-DC200BR

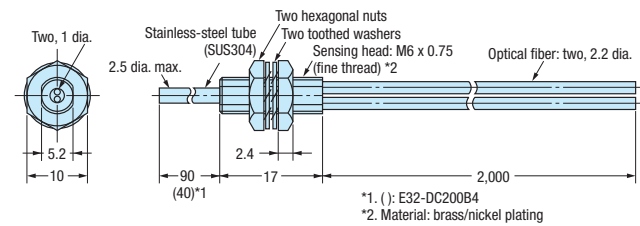

## E32-DC200E

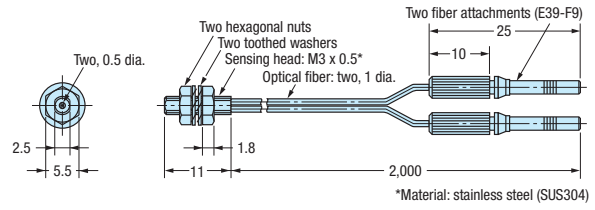

## E32-DC200F, E32-DC200FR

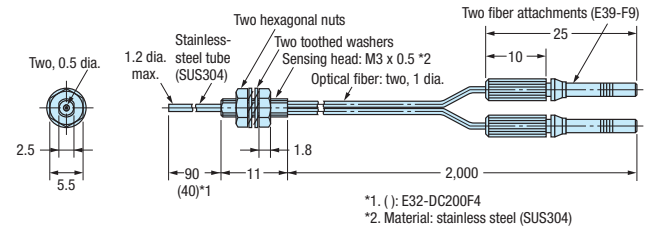

## E32-EC31

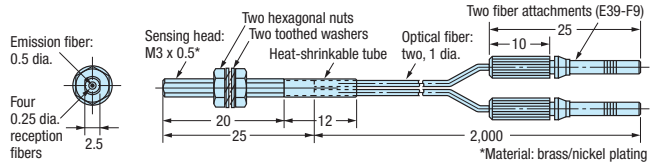

## E32-EC41

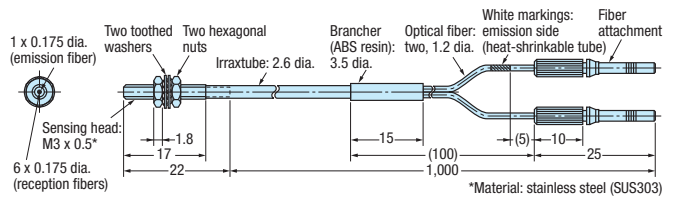

## E32-ED11F

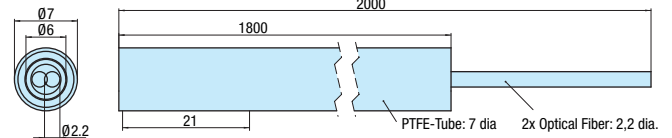

## E32-ED11R

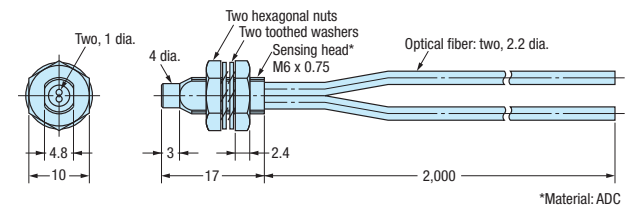

## E32-ED21R

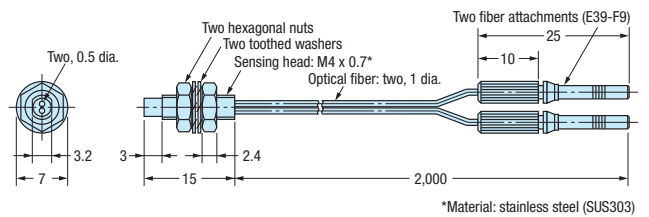

# Product dimensions

**E32-ED51**

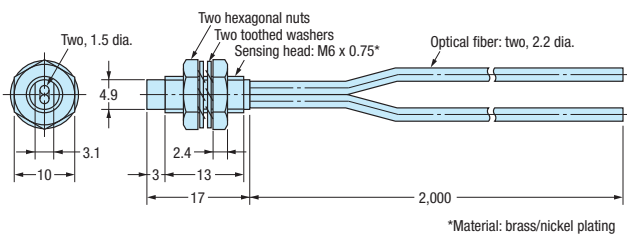

**E32-EDS24R**

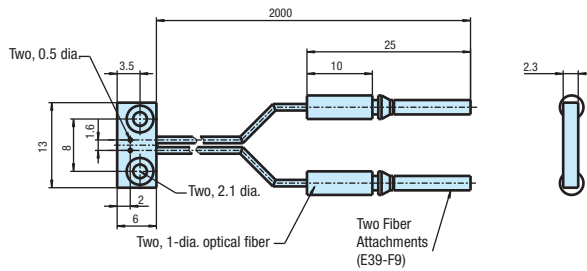

**E32-EL24-1**

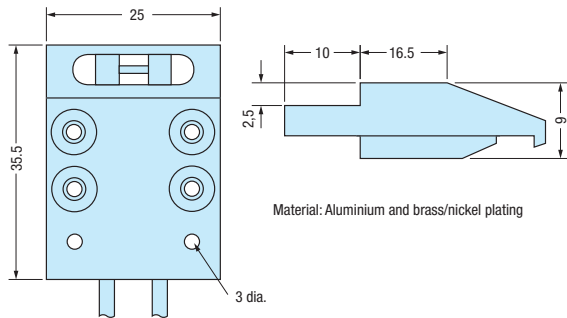

**E32-ET11F**

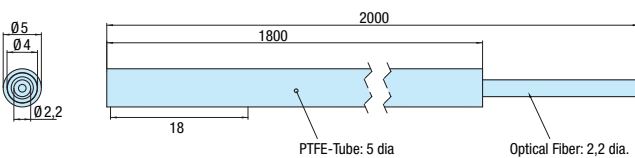

**E32-ET11R**

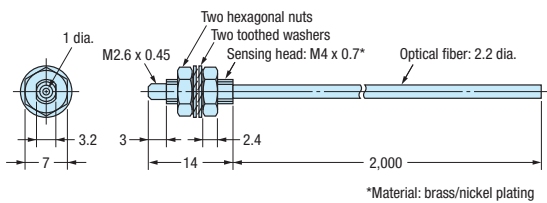

**E32-ET16WR-1**

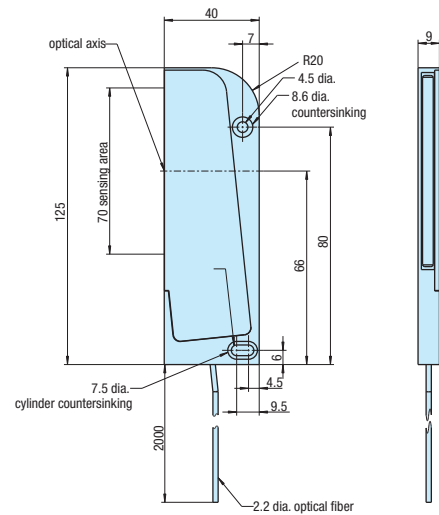

**E32-ET16WR-2**

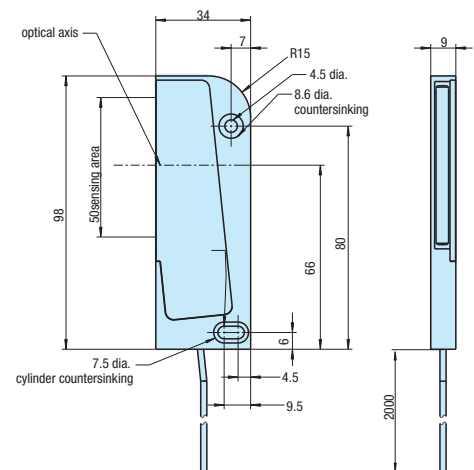

**E32-ET21R**

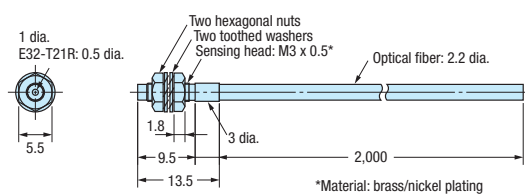

**E32-ET51**

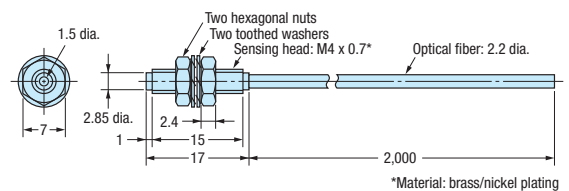

**E32-ETC220 2M**

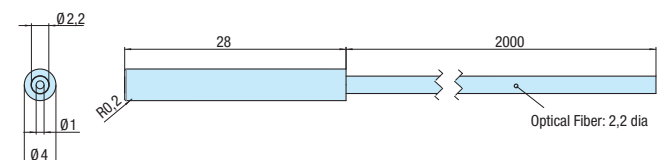

# Product dimensions

## E32-ETS10R

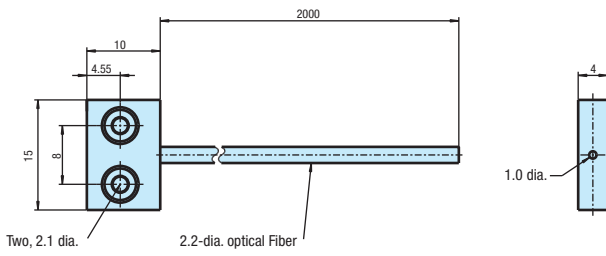

## E32-ETS14R

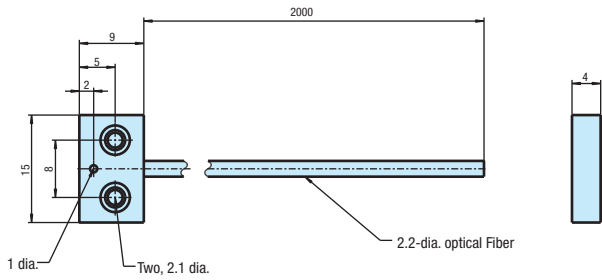

## E32-G14

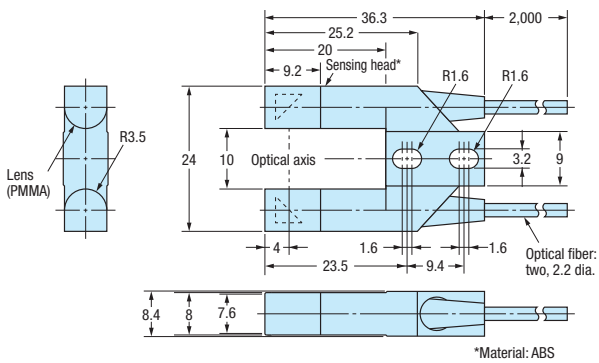

## E32-L11FS

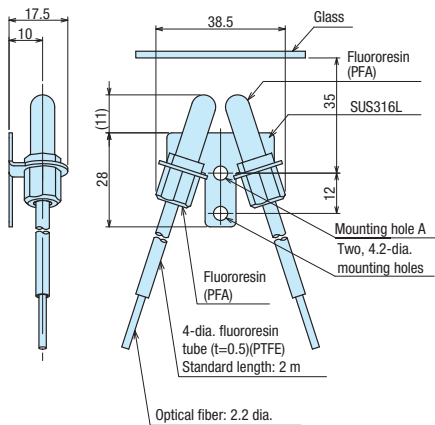

## E32-L16-N

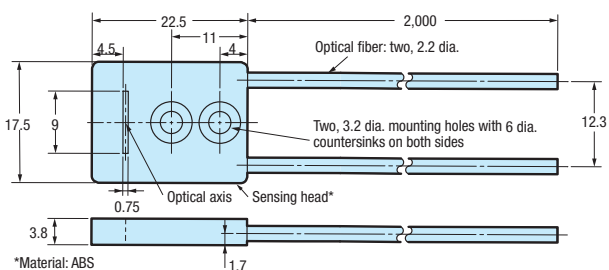

## E32-L24L

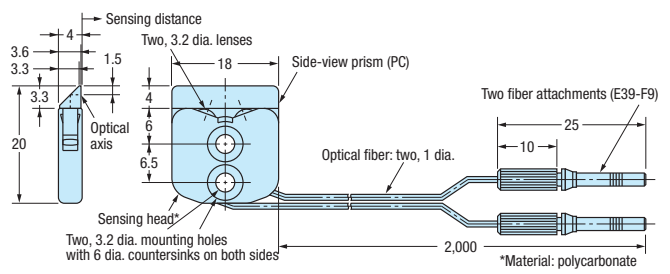

## E32-L25

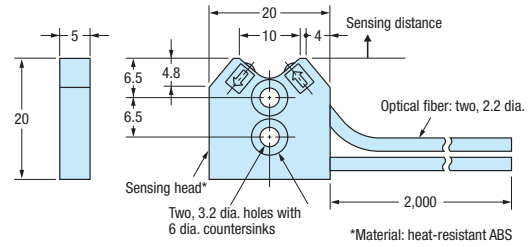

## E32-L25L

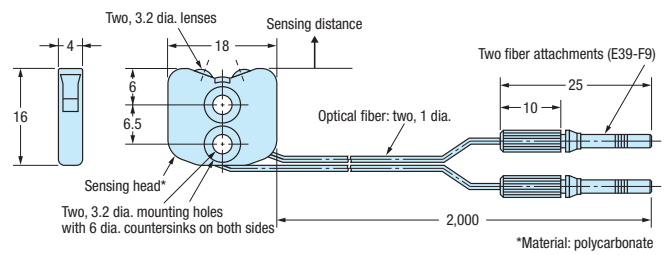

## E32-L64

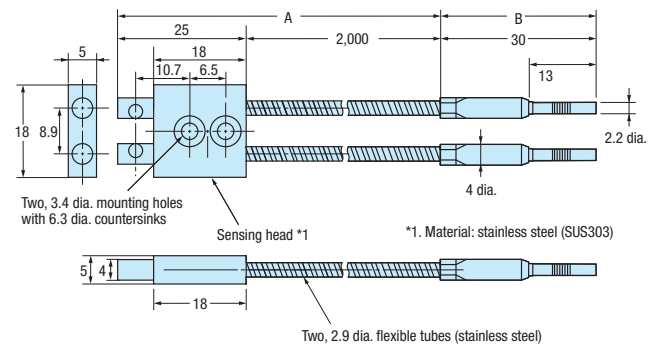

## E32-L66

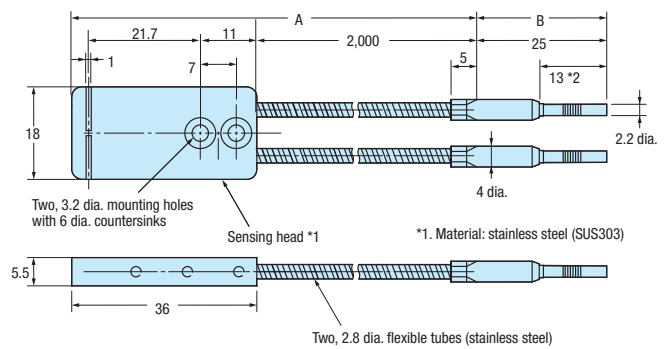

# Product dimensions

## E32-M21

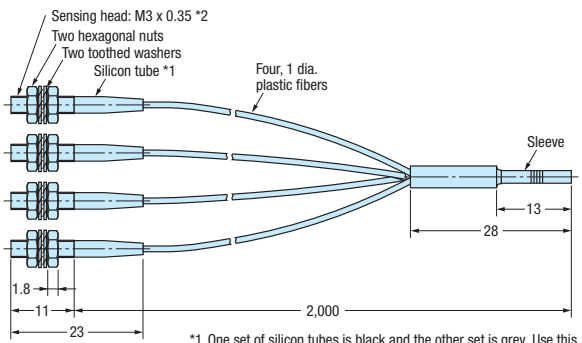

\*1. One set of silicon tubes is black and the other set is grey. Use this difference to distinguish between the emission and reception sides.  
\*2. Material: stainless steel (SUS303)

## E32-R16

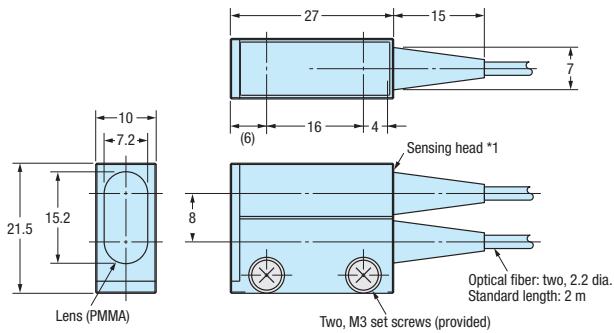

## E32-R21

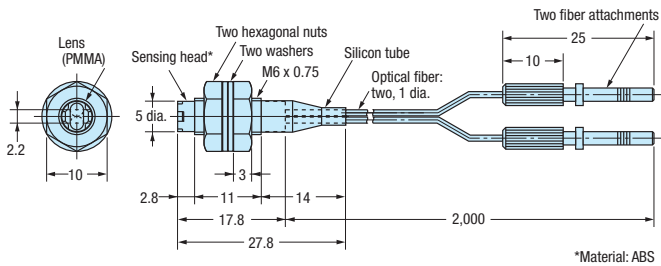

## E32-T11, E32-T11U

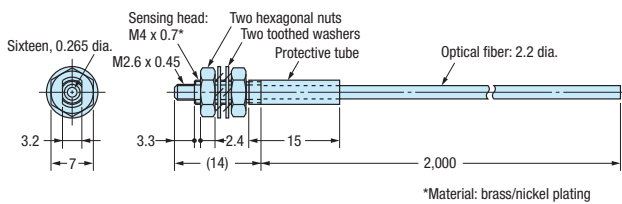

## E32-T11L

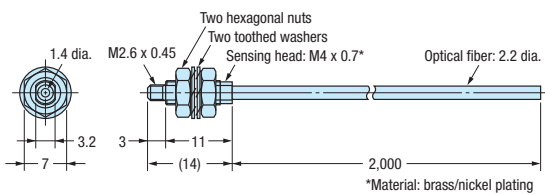

## E32-T11N

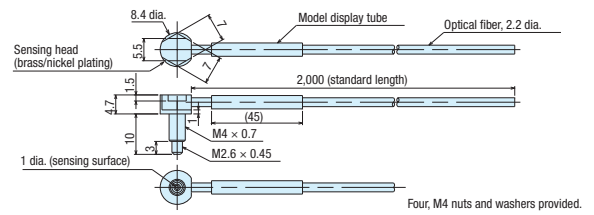

## E32-T12, E32-T12R

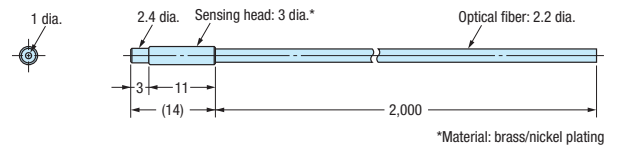

## E32-T12B

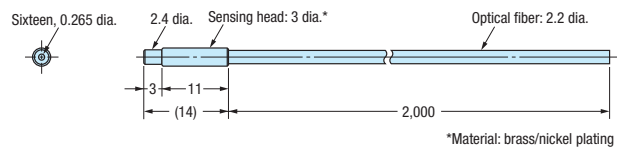

## E32-T12F

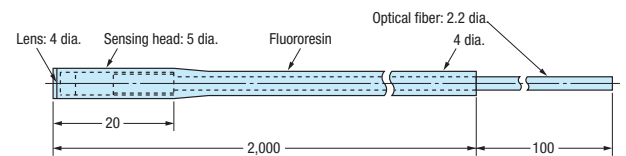

## E32-T12L

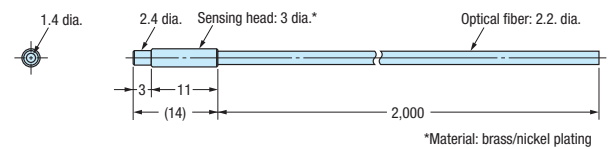

## E32-T14

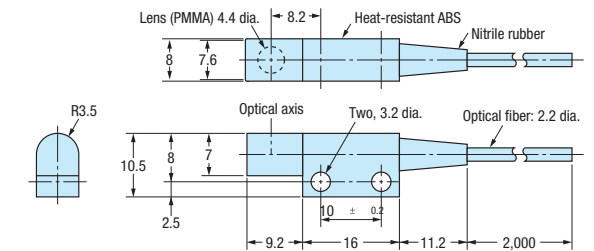

## E32-T14F

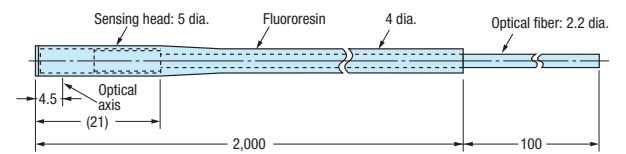

# Product dimensions

## E32-T14L, E32-T14LR

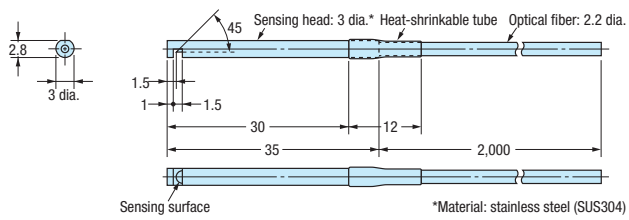

## E32-T15X

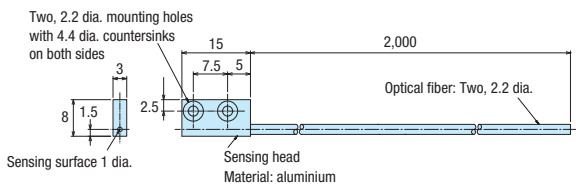

## E32-T15XB

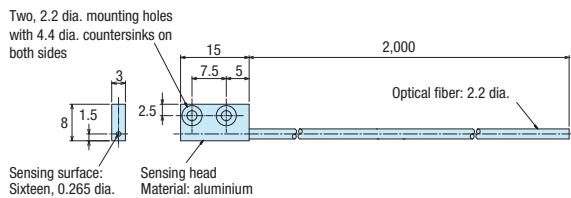

## E32-T15Y, E32-T15YR

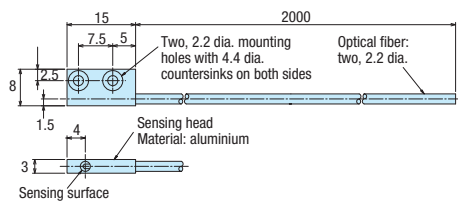

## E32-T15Z

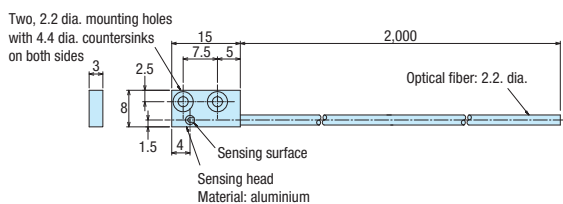

## E32-T16

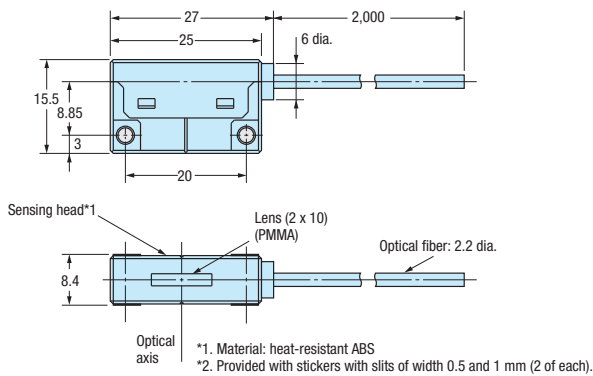

## E32-T16J, E32-T16JR

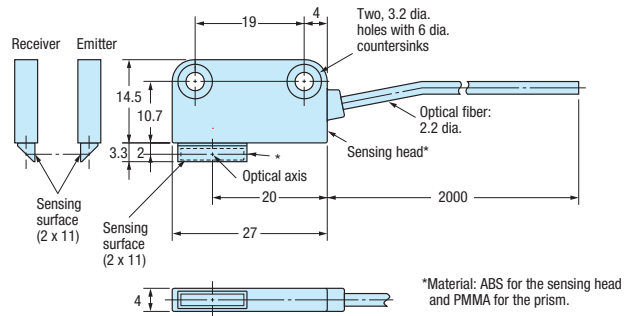

## E32-T16P, E32-T16PR

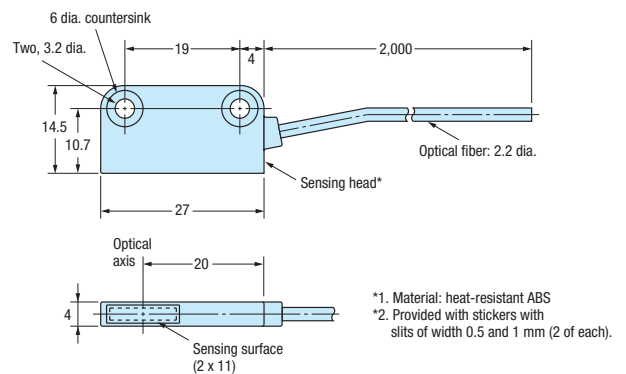

## E32-T16W, E32-T16WR

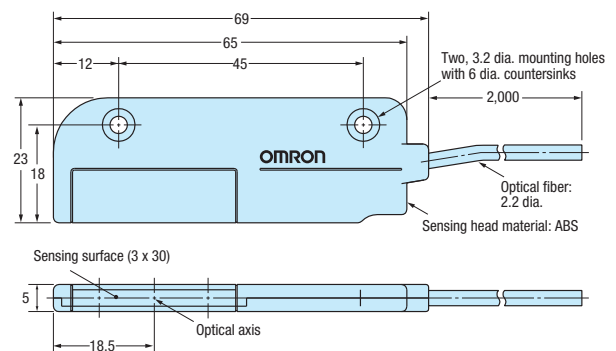

## E32-T17L

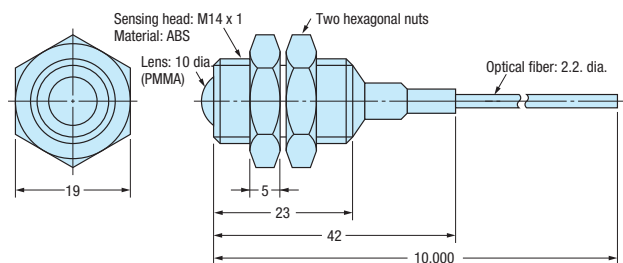

## E32-T21

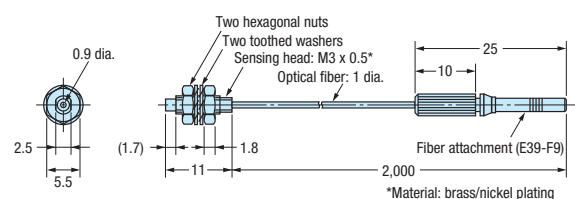

# Product dimensions

## E32-T22, E32-T22R

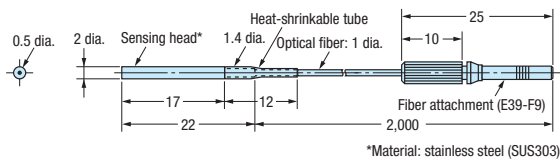

## E32-T22B

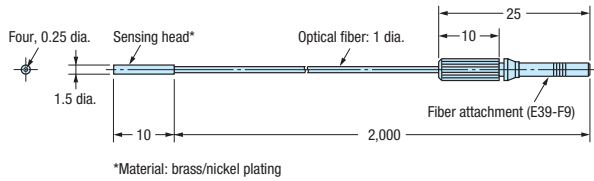

## E32-T22L

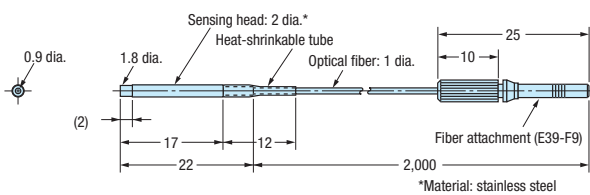

## E32-T22S

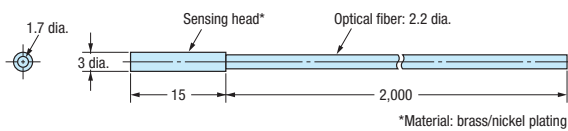

## E32-T24, E32-T24R

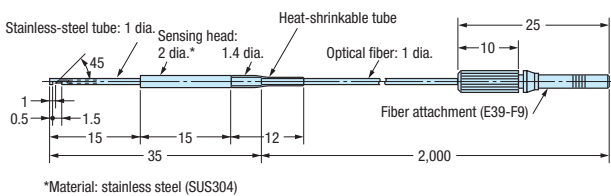

## E32-T24S

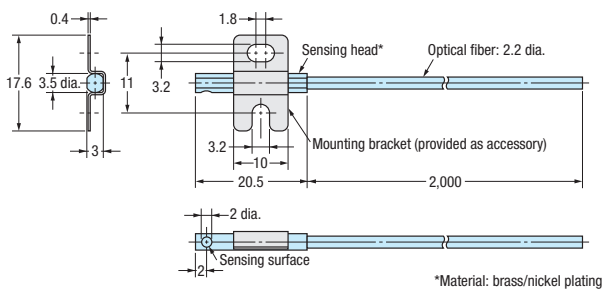

## E32-T51F

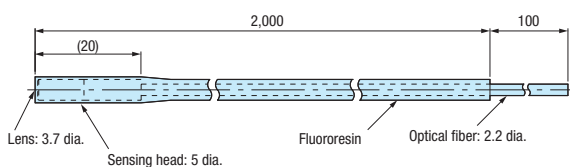

## E32-T51R

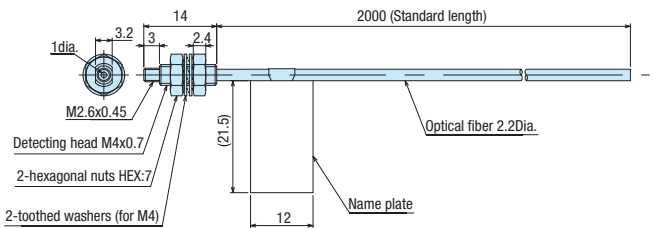

## E32-T51V

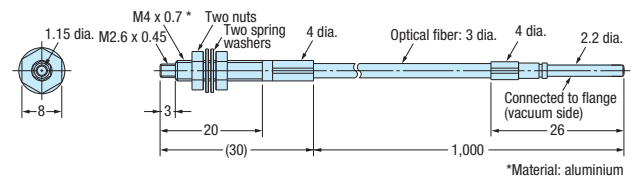

## E32-T54

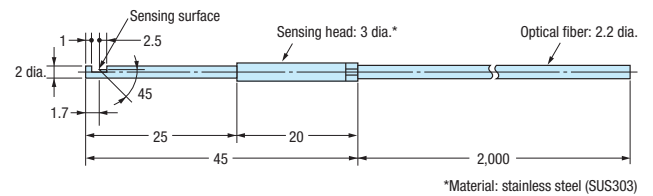

## E32-T54V

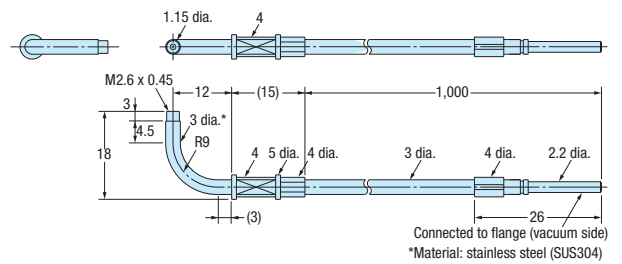

## E32-T61-S

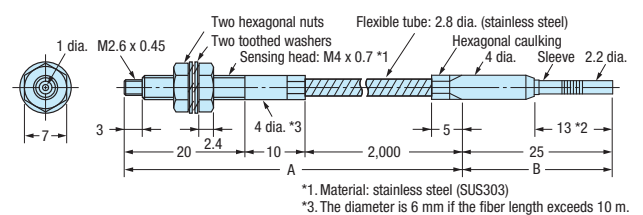

## E32-T81F-S

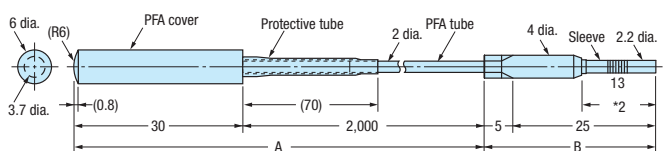

## E32-T81R-S

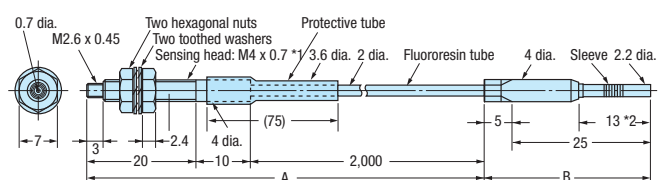

\*1. Material: stainless steel (SUS303)



# Product dimensions

## E32-T84S-S

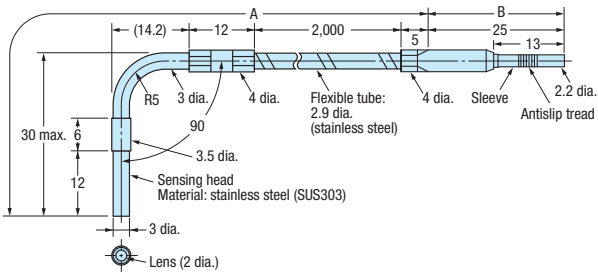

## E32-T84SV

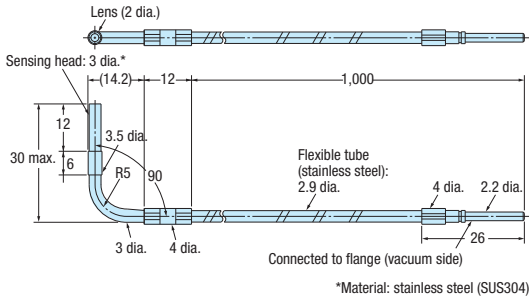

## E32-T221B

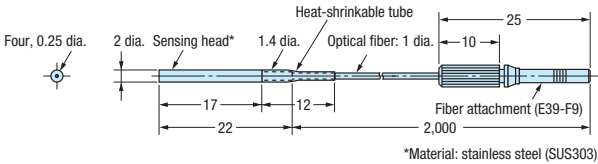

## E32-T222, E32-T222R

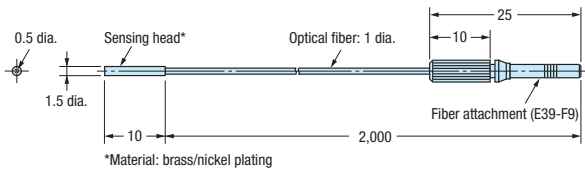

## E32-T223R

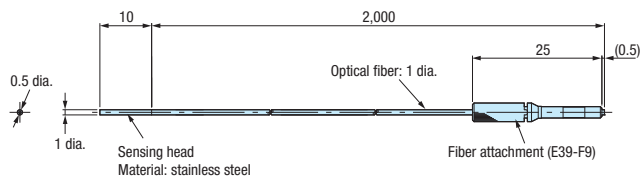

## E32-TC200

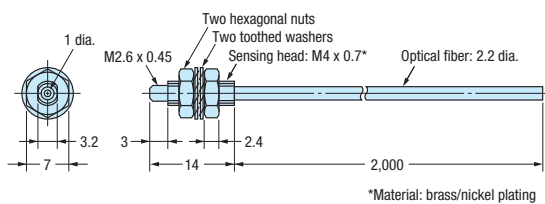

## E32-TC200A

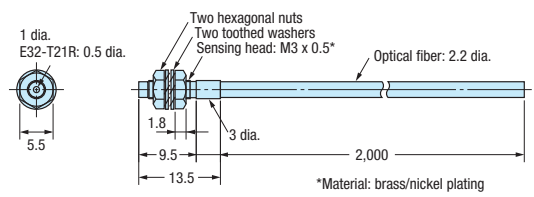

## E32-TC200B, E32-TC200BR

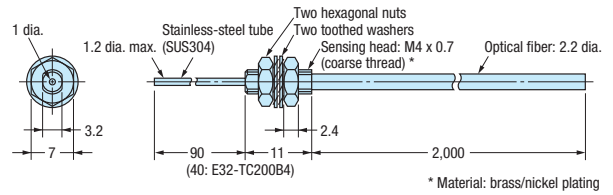

## E32-TC200E

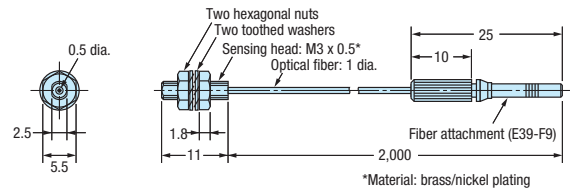

## E32-TC200F, E32-TC200FR

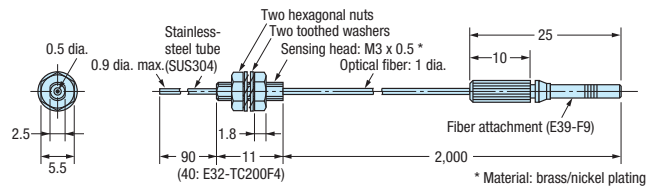

## E39-EF1-37

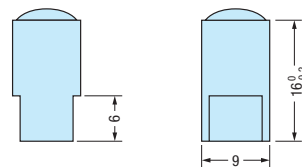

## E39-EF51

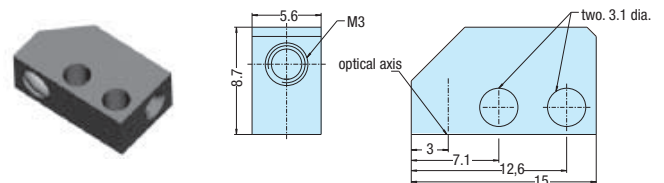

## E39-F1

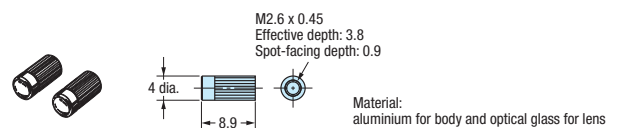

# Product dimensions

## E39-F1V

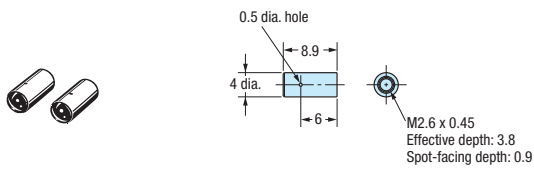

## E39-F2

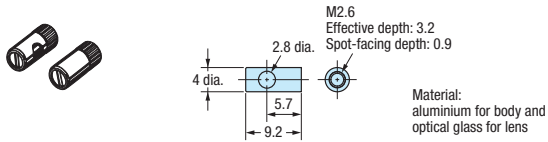

## E39-F3A

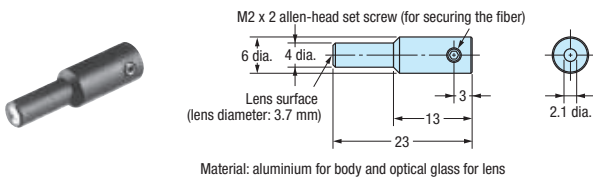

## E39-F3A-5

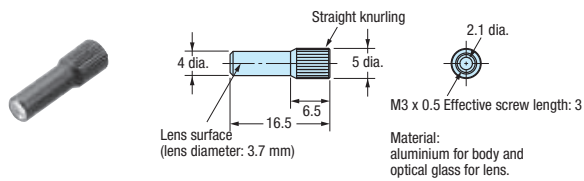

## E39-F3B

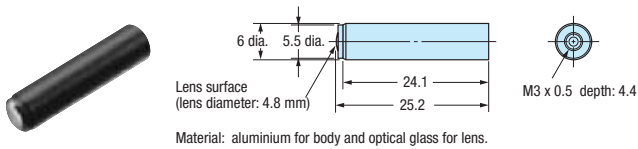

## E39-F4

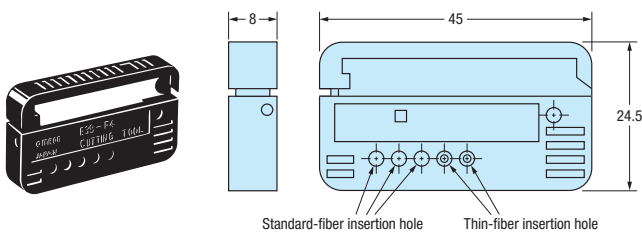

## E39-F9

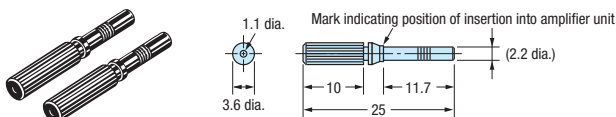

## E39-F10

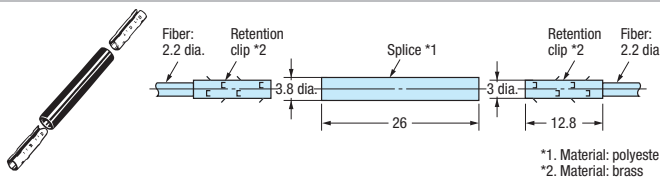

## E39-F11

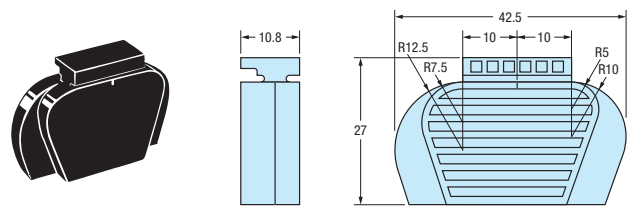

## E39-F13, E39-F14, E39-F15

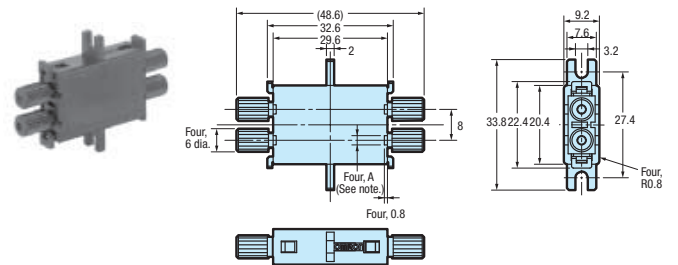

## E39-F16

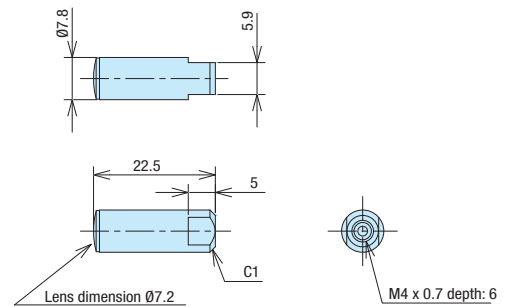

## E39-F18

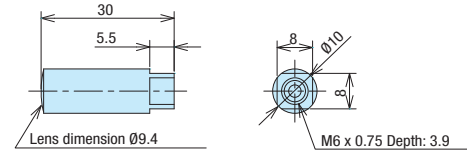

## E39-F32A, E39-F32B

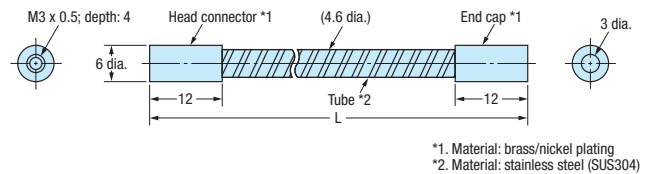

## E39-F32C

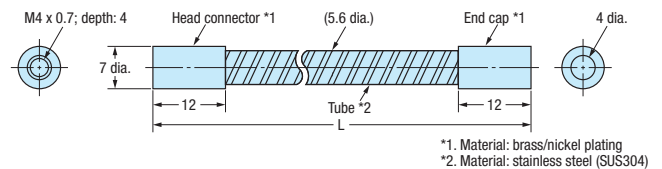

## E39-F32D

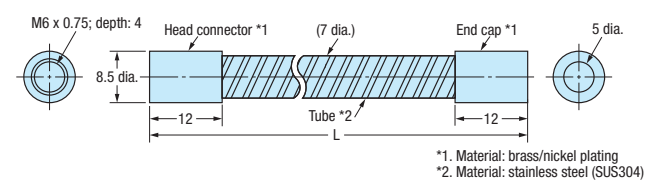



# Product dimensions

## Amplifier

### E3X-DA\_ amplifiers (teachable) - exemplary drawing for connector version

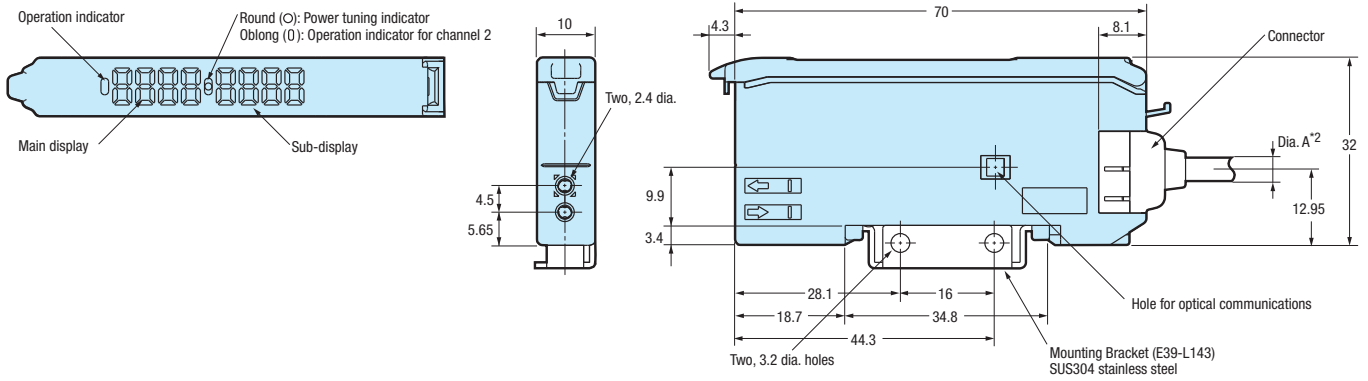

### E3X-NA amplifiers (manual adjuster) - exemplary drawing for M8 connector version

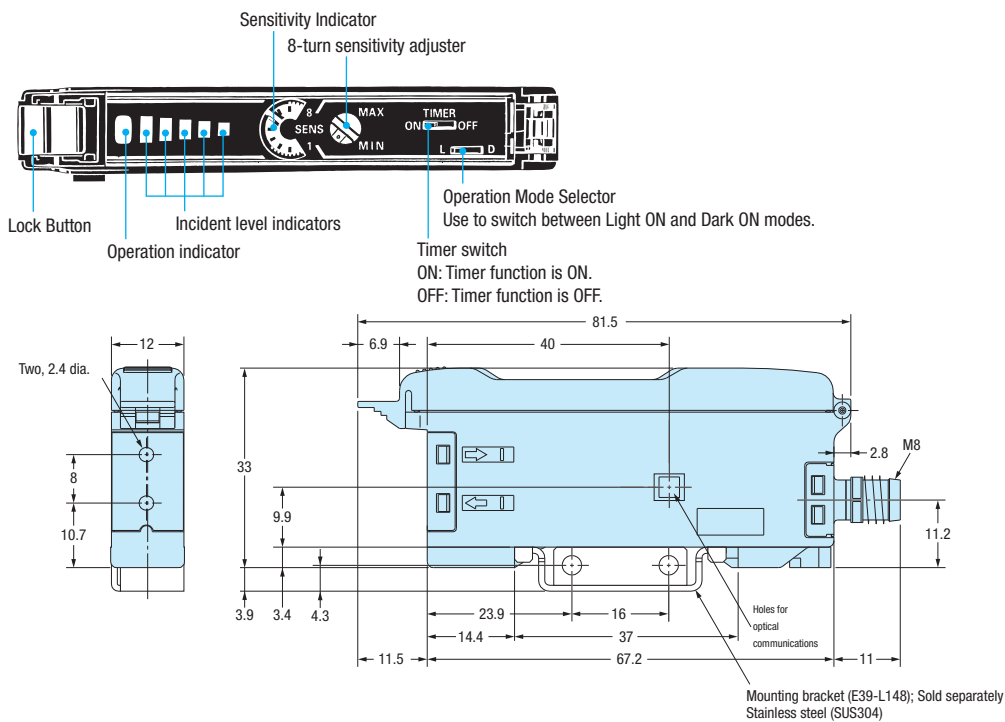

### E3X-SD\_ amplifiers - exemplary drawing for pre-wired version

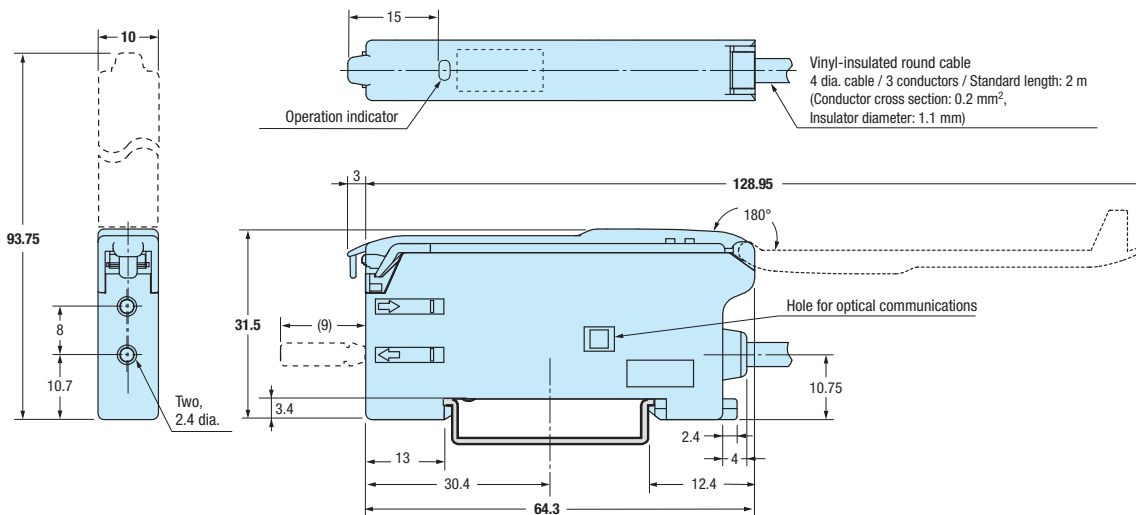

# Precautions

## Fiber Units

### Installation

#### Tightening Force

The tightening force applied to the Fiber Unit should be as follows:

#### Screw-mounting Model Cylindrical Model

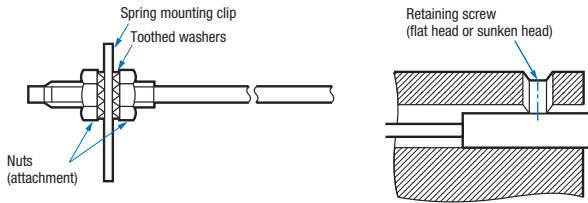

Fiber Units	Clamping torque
M3/M4 screw	0.78 Nm max.
M6 screw/6-mm dia. column	0.98 Nm max.
1.5-mm dia. column	0.2 Nm max.
2-mm dia./3-mm dia. column	0.29 Nm max.
E32-T12F 5-mm dia. Teflon model	0.78 Nm max.
E32-D12F 6-mm dia. Teflon model	
E32-T16	0.49 Nm max.
E32-R21	0.59 Nm max.
E32-M21	0.49 Nm max. for up to 5 mm from front end, 0.78 Nm max. for more than 5 mm from front end
E32-T16P E32-T16PR E32-T24S E32-L24L E32-L25L E32-T16J E32-T16JR	0.29 Nm max.
E32-ET16W E32-ET16WR	0.3 Nm max.

Use a proper-sized wrench.

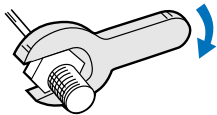

### Cutting Fiber

- Insert a fiber into the Fiber Cutter and determine the length of the fiber to be cut.
- Press down the Fiber Cutter in a single stroke to cut the fiber.
- Cut a thin fiber as follows:

①	An attachment is temporarily fitted to a thin fiber before shipment.	
②	Secure the attachment after adjusting the position of it in the direction indicated by the arrow.	
③	Insert the fiber to be cut into the E39-F4.	

④	Finished state (proper cutting state)	
---	---------------------------------------	--

**Note:** Insert the fiber in the direction indicated by the arrow.

### Connection

- Do not pull or press the fiber units. The fiber units withstand tensile or compression force of 9.8 N or 29.4 N maximum.
- Do not bend the fiber unit beyond the permissible bending radius given under Ordering Information.
- Do not bend the edge of the fiber units (excluding the E32-T□R and E32-D□R).

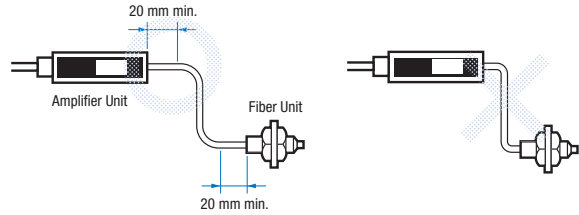

- Do not apply excess force on the fiber units.

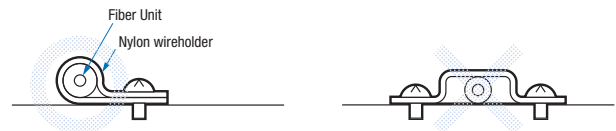

- The fiber head may break due to excessive vibration. A one turn loop may reduce the effect of vibrations:

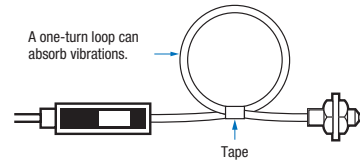

### E39-F11 Sleeve Bender

- The bending radius of the stainless steel tube should be as large as possible. The smaller the bending radius becomes, the shorter the sensing distance will be.
- Insert the tip of the stainless steel tube to the sleeve bender and bend the stainless steel tube slowly along the curve of the sleeve bender (refer to the figure).

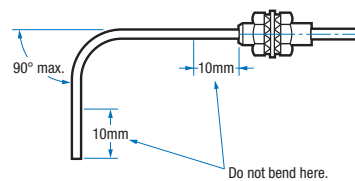
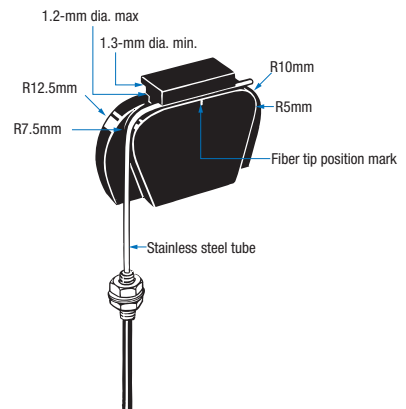

# Precautions

## Heat-resistant fibers

- The fiber connector E39-F10 cannot be used for extension.

## E32-T14/E32-G14

The presence of a reflective object at the front ends of the lenses may place the unit in an incident state. In this case, apply the supplied black stickers to the front ends of the lenses.

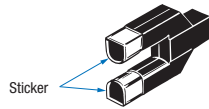

## Supplied slit for E32-T16

When using the supplied slit, peel off the back paper and apply it along the outline of the sensing surface. The slit is recommended in applications where saturation occurs.

### Example

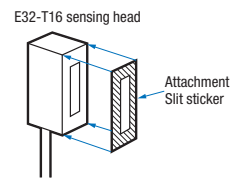

## E32-M21

To prevent mutual interference sufficient distance between the four sensing heads has to be ensured.

## Adjustment

### E32-G14

Due to the short distance between the sensor heads, two-point teaching (with and without object) is recommended.

## Accessories

### Protective Spiral Tubes

- Insert a fiber to the protective spiral tube from the head connector side (screwed) of the tube.

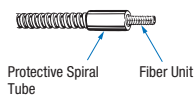

- Push the fiber into the protective spiral tube. The tube should be straight so that the fiber is not twisted when inserted. Then turn the end cap of the spiral tube.

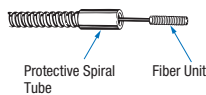

- Secure the protective spiral tube at a suitable place with the attached nut.

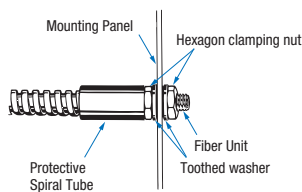

- Use the attached saddle to secure the end cap of the protective spiral tube. To secure the protective spiral tube at a position other than the end cap, apply tape to the tube so that the portion becomes thicker in diameter.

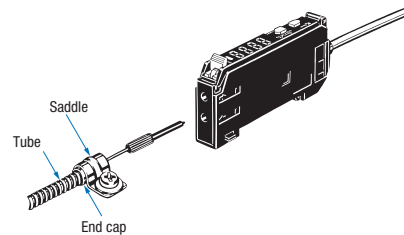

## E39-F10 Fiber Connector

Fit the connector in the following procedure.

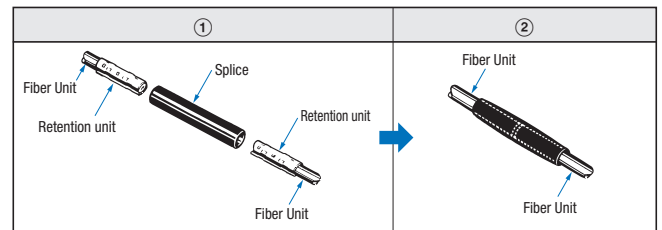

- The fiber units should be as close as possible when they are connected. Sensing distance will be reduced by approximately 25% when fibers are connected.

**Note:** Only 2.2 mm dia. fibers can be connected.



# Precautions

## Amplifier Unit

### Installation

#### Operation after Turning Power ON

The Amplifier Unit is ready to operate within 200 ms after the power supply is turned ON. If the Sensor and load are connected to power supplies separately, be sure to turn ON the power supply to the Sensor first.

### Mounting

#### Connecting and Disconnecting Connectors

#### Mounting Connectors

1. Insert the Master or Slave Connector into the Amplifier Unit until it clicks into place.

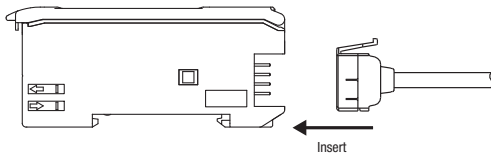

2. Attach the protector seals (provided as accessories) to the sides of master and slave connectors that are not connected.

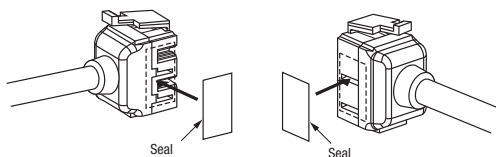

**Note:** Attach the seals to the sides with grooves

#### Removing Connectors

1. Slide the slave Amplifier Unit(s) for which the Connector is to be removed away from the rest of the group.
2. After the Amplifier Unit(s) has been separated, press down on the lever on the Connector and remove it. (Do not attempt to remove Connectors without separating them from other Amplifier Units first.)

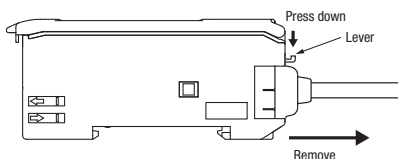

### Joining and Removing Amplifier Units

#### Joining Amplifier Units

1. Mount the Amplifier Units one at a time onto the DIN track.

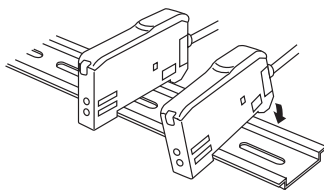

2. Slide the Amplifier Units together, line up the clips, and press the Amplifier Units together until they click into place.

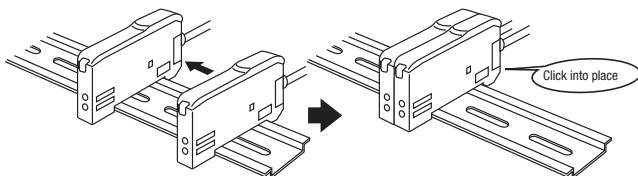

#### Separating Amplifier Units

Slide Amplifier Units away from each other, and remove from the DIN track one at a time. (Do not attempt to remove Amplifier Units from the DIN track without separating them first.)

- Note:**
- The specifications for ambient temperature will vary according to the number of Amplifier Units used together. For details, refer to Ratings/Characteristics.
  - Always turn OFF the power supply before joining or separating Amplifier Units.

### Mounting the End Plate (PFP-M)

An End Plate should be used if there is a possibility of the Amplifier Unit moving, e.g., due to vibration. If a Mobile Console is going to be mounted, connect the End Plate in the direction shown in the following diagram.

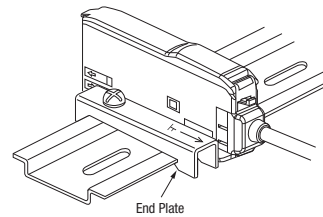

### Mounting the Mobile Console Head

Leave a gap of at least 20 mm between the nearest Amplifier Unit and the Mobile Console head.

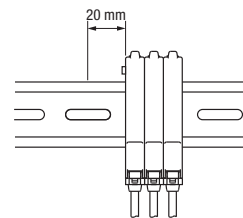

### Fiber Connection

The E3X Amplifier Unit has a lock button for easy connection of the Fiber Unit. Connect or disconnect the fibers using the following procedures:

#### 1. Connection

Open the protective cover, insert the fibers according to the fiber insertion marks on the side of the Amplifier Unit, and lower the lock button.

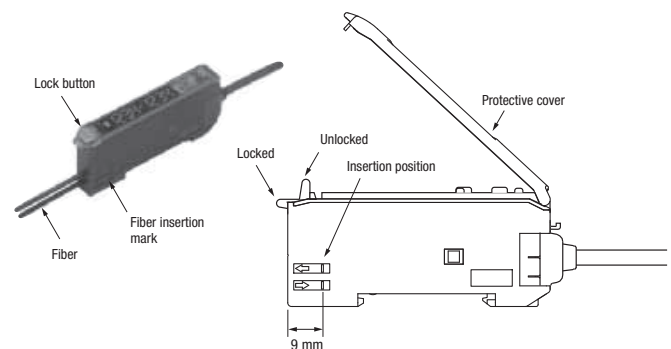

#### Fibers with E39-F9 Attachment

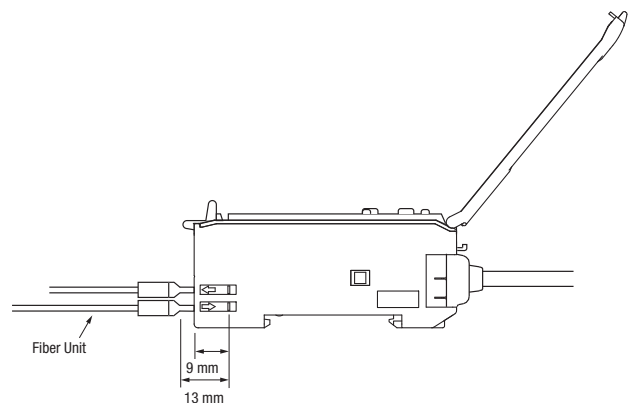

# Precautions

## Fibers That Cannot Be Free-Cut (with Sleeves)

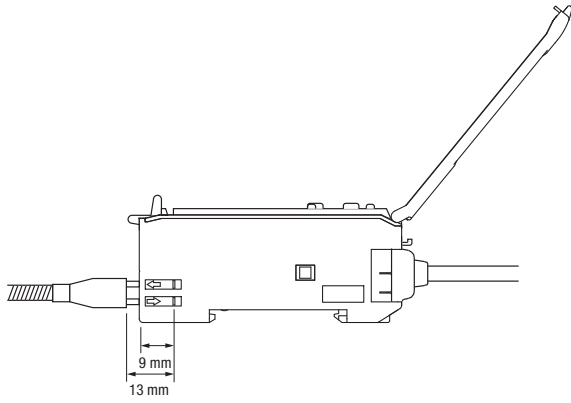

### 2. Disconnecting Fibers

Remove the protective cover and raise the lock button to pull out the fibers.

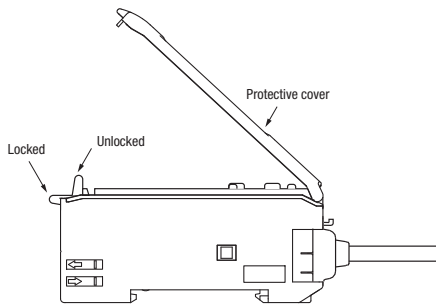

- Note:**
- To maintain the fiber properties, confirm that the lock is released before removing the fibers.
  - Be sure to lock or unlock the lock button within an ambient temperature range between  $-10^{\circ}\text{C}$  and  $40^{\circ}\text{C}$ .

### Protective Cover

Always keep the protective cover in place when using the Amplifier Unit.

- Note:** For complete precautions and installation instructions refer to individual amplifier datasheets.



# Product list

Order code	Group	Page	Order code	Group	Page	Order code	Group	Page
E32-A03 2M	Precision detection	16	E32-EC31 2M	Precision detection	16	E32-T24S	Special application	19
	Special application	19		Special application	19	E32-T51F 2M	Chemical resistant	11
E32-A03-1 2M	Square shape	7	E32-EC41 1M	Precision detection	16	E32-T51R 2M	Heat resistant	12
E32-A04 2M	Miniature	8	E32-ED11F 2M	Chemical resistant	11	E32-T51V 1M	Vacuum resistant	14
	Precision detection	16	E32-ED11R 2M	Standard cylindrical	6	E32-T54 2M	Heat resistant	12
	Special application	19	E32-ED21R 2M	Standard cylindrical	6	E32-T54V 1M	Vacuum resistant	14
E32-A04-1 2M	Square shape	7	E32-ED51 2M	Heat resistant	12	E32-T61-S 2M	Heat resistant	12
E32-A09 2M	Precision detection	16	E32-EDS24R 2M	Square shape	7	E32-T81F-S 2M	Chemical resistant	11
	Special application	19	E32-EL24-1 2M	Precision detection	16	E32-T81R-S 2M	Heat resistant	12
E32-A09H 2M	Heat resistant	12		Special application	19	E32-T84S-S 2M	Heat resistant	12
E32-A09H2 2M	Heat resistant	12	E32-ET11F 2M	Chemical resistant	11	E32-T84SV 1M	Vacuum resistant	14
E32-A10 2M	Special application	19	E32-ET11R 2M	Standard cylindrical	6	E32-T221B	Robot applications	15
E32-C11N 2M	Precision detection	16	E32-ET16WR-1 2M	Area monitoring	18	E32-T222 2M	Miniature	8
E32-C31N 2M	Precision detection	16	E32-ET16WR-2 2M	Area monitoring	18	E32-T222R 2M	Miniature	8
E32-C42 1M	Precision detection	16	E32-ET21R 2M	Standard cylindrical	6	E32-T223R 2M	Miniature	8
E32-CC200 2M	Precision detection	16	E32-ET51 2M	Heat resistant	12	E32-TC200 2M	Standard cylindrical	6
	Special application	19	E32-ETC220 2M	Standard cylindrical	6	E32-TC200A 2M	Longer distance	10
E32-D11 2M	Robot applications	15	E32-ETS10R 2M	Square shape	7	E32-TC200B	Miniature	8
E32-D11L 2M	Longer distance	10	E32-ETS14R 2M	Square shape	7	E32-TC200BR	Miniature	8
E32-D11N 2M	Standard cylindrical	6	E32-G14	Special application	19	E32-TC200E 2M	Standard cylindrical	6
E32-D11U 2M	Chemical resistant	11	E32-L11FS	Special application	19	E32-TC200F	Miniature	8
E32-D12 2M	Longer distance	10	E32-L16-N 2M	Precision detection	16	E32-TC200FR	Miniature	8
E32-D12F	Chemical resistant	11	E32-L24L	Precision detection	16	E39-EF1-37	Accessories	21
E32-D14F 2M	Chemical resistant	11		Special application	19	E39-EF51	Accessories	21
E32-D14L 2M	Standard cylindrical	6	E32-L25	Precision detection	16	E39-F1	Accessories	21
E32-D14LR 2M	Standard cylindrical	6	E32-L25L	Precision detection	16	E39-F10	Accessories	21
E32-D15X 2M	Square shape	7		Special application	19	E39-F11	Accessories	21
E32-D15XB 2M	Robot applications	15	E32-L64	Heat resistant	12	E39-F13	Accessories	21
E32-D15XR 2M	Square shape	7		Special application	19	E39-F14	Accessories	21
E32-D15Y 2M	Square shape	7	E32-L66 2M	Heat resistant	12	E39-F15	Accessories	21
E32-D15YR 2M	Square shape	7		Special application	19	E39-F16	Accessories	21
E32-D15Z 2M	Square shape	7	E32-M21	Area monitoring	18	E39-F18	Accessories	21
E32-D16 2M	Longer distance	10	E32-R16 2M	Longer distance	10	E39-F1V	Accessories	21
E32-D21 2M	Robot applications	15	E32-R21	Standard cylindrical	6	E39-F2	Accessories	21
E32-D21B 2M	Robot applications	15	E32-T11 2M	Robot applications	15	E39-F32A	Accessories	21
E32-D21L 2M	Longer distance	10	E32-T11L 2M	Longer distance	10	E39-F32B	Accessories	21
E32-D22 2M	Miniature	8	E32-T11N 2M	Standard cylindrical	6	E39-F32C	Accessories	21
E32-D22B 2M	Miniature	8	E32-T11U 2M	Chemical resistant	11	E39-F32D	Accessories	21
	Robot applications	15	E32-T12 2M	Miniature	8	E39-F3A	Accessories	21
E32-D22R 2M	Miniature	8	E32-T12B	Robot applications	15	E39-F3A-5	Accessories	21
E32-D24	Miniature	8	E32-T12F	Chemical resistant	11	E39-F3B	Accessories	21
E32-D24R 2M	Miniature	8	E32-T12L 2M	Longer distance	10	E39-F4	Accessories	21
E32-D32 2M	Miniature	8	E32-T12R 2M	Miniature	8	E39-F9	Accessories	21
	Precision detection	16	E32-T14 2M	Longer distance	10	E39-R1S	Accessories	21
E32-D32L 2M	Precision detection	16	E32-T14F 2M	Chemical resistant	11	E39-R3	Accessories	21
E32-D32R 2M	Miniature	8	E32-T14L 2M	Miniature	8	E3X-CN21	Accessories	21
E32-D33 2M	Miniature	8	E32-T14LR 2M	Miniature	8	E3X-CN21-M1J	Accessories	21
E32-D36P1 2M	Area monitoring	18	E32-T15X 2M	Square shape	7	E3X-CN21-M3J-2	Accessories	21
E32-D36T 2M	Special application	19	E32-T15XB 2M	Robot applications	15	E3X-DA_-S	Advanced amplifiers	24
E32-D51R 2M	Heat resistant	12	E32-T15Y 2M	Square shape	7	E3X-DA_SE-S	Easy usage amplifiers	22
E32-D61/ D61-S 2M	Heat resistant	12	E32-T15YR 2M	Square shape	7	E3X-DAC_-S	Advanced amplifiers	28
E32-D73/ D73-S 2M	Heat resistant	12	E32-T15Z 2M	Square shape	7	E3X-DAH-S	Advanced amplifiers	30
E32-D81R/ D81R-S 2M	Heat resistant	12	E32-T16	Area monitoring	18	E3X-MDA_	Advanced amplifiers	26
E32-D82F1 4M	Special application	19	E32-T16J 2M	Area monitoring	18	E3X-NA	Easy usage amplifiers	23
E32-D211 2M	Standard cylindrical	6	E32-T16JR 2M	Area monitoring	18	E3X-NA_F	Advanced amplifiers	27
E32-D211R 2M	Standard cylindrical	6	E32-T16P	Area monitoring	18	E3X-SD	Easy usage amplifiers	23
E32-D331 2M	Miniature	8	E32-T16PR 2M	Area monitoring	18			
E32-DC200 2M	Standard cylindrical	6	E32-T16W 2M	Area monitoring	18			
E32-DC200B 2M	Miniature	8	E32-T16WR 2M	Area monitoring	18			
E32-DC200BR	Miniature	8	E32-T17L	Longer distance	10			
E32-DC200E 2M	Standard cylindrical	6	E32-T21 2M	Robot applications	15			
E32-DC200F	Miniature	8	E32-T22 2M	Miniature	8			
E32-DC200FR	Miniature	8	E32-T22B	Robot applications	15			
E32-E01 100M	Accessories	21	E32-T22L 2M	Longer distance	10			
E32-E01R 100M	Accessories	21	E32-T22R 2M	Miniature	8			
E32-E02 100M	Accessories	21	E32-T22S	Precision detection	16			
E32-E02R 100M	Accessories	21		Special application	19			
E32-E05 100M	Accessories	21	E32-T24	Miniature	8			
			E32-T24R 2M	Miniature	8			

---

## READ AND UNDERSTAND THIS DOCUMENT

---

Please read and understand this document before using the products. Please consult your OMRON representative if you have any questions or comments.

## WARRANTY

---

OMRON's exclusive warranty is that the products are free from defects in materials and workmanship for a period of one year (or other period if specified) from date of sale by OMRON.

OMRON MAKES NO WARRANTY OR REPRESENTATION, EXPRESS OR IMPLIED, REGARDING NON-INFRINGEMENT, MERCHANTABILITY, OR FITNESS FOR PARTICULAR PURPOSE OF THE PRODUCTS. ANY BUYER OR USER ACKNOWLEDGES THAT THE BUYER OR USER ALONE HAS DETERMINED THAT THE PRODUCTS WILL SUITABLY MEET THE REQUIREMENTS OF THEIR INTENDED USE. OMRON DISCLAIMS ALL OTHER WARRANTIES, EXPRESS OR IMPLIED.

## LIMITATIONS OF LIABILITY

---

OMRON SHALL NOT BE RESPONSIBLE FOR SPECIAL, INDIRECT, OR CONSEQUENTIAL DAMAGES, LOSS OF PROFITS OR COMMERCIAL LOSS IN ANY WAY CONNECTED WITH THE PRODUCTS, WHETHER SUCH CLAIM IS BASED ON CONTRACT, WARRANTY, NEGLIGENCE, OR STRICT LIABILITY.

In no event shall responsibility of OMRON for any act exceed the individual price of the product on which liability is asserted.

IN NO EVENT SHALL OMRON BE RESPONSIBLE FOR WARRANTY, REPAIR, OR OTHER CLAIMS REGARDING THE PRODUCTS UNLESS OMRON'S ANALYSIS CONFIRMS THAT THE PRODUCTS WERE PROPERLY HANDLED, STORED, INSTALLED, AND MAINTAINED AND NOT SUBJECT TO CONTAMINATION, ABUSE, MISUSE, OR INAPPROPRIATE MODIFICATION OR REPAIR.

## SUITABILITY FOR USE

---

THE PRODUCTS CONTAINED IN THIS DOCUMENT ARE NOT SAFETY RATED. THEY ARE NOT DESIGNED OR RATED FOR ENSURING SAFETY OF PERSONS, AND SHOULD NOT BE RELIED UPON AS A SAFETY COMPONENT OR PROTECTIVE DEVICE FOR SUCH PURPOSES. Please refer to separate catalogs for OMRON's safety rated products.

OMRON shall not be responsible for conformity with any standards, codes, or regulations that apply to the combination of products in the customer's application or use of the product.

At the customer's request, OMRON will provide applicable third party certification documents identifying ratings and limitations of use that apply to the products. This information by itself is not sufficient for a complete determination of the suitability of the products in combination with the end product, machine, system, or other application or use.

The following are some examples of applications for which particular attention must be given. This is not intended to be an exhaustive list of all possible uses of the products, nor is it intended to imply that the uses listed may be suitable for the products:

- Outdoor use, uses involving potential chemical contamination or electrical interference, or conditions or uses not described in this document.
- Nuclear energy control systems, combustion systems, railroad systems, aviation systems, medical equipment, amusement machines, vehicles, safety equipment, and installations subject to separate industry or government regulations.
- Systems, machines, and equipment that could present a risk to life or property.

Please know and observe all prohibitions of use applicable to the products.

NEVER USE THE PRODUCTS FOR AN APPLICATION INVOLVING SERIOUS RISK TO LIFE OR PROPERTY WITHOUT ENSURING THAT THE SYSTEM AS A WHOLE HAS BEEN DESIGNED TO ADDRESS THE RISKS, AND THAT THE OMRON PRODUCT IS PROPERLY RATED AND INSTALLED FOR THE INTENDED USE WITHIN THE OVERALL EQUIPMENT OR SYSTEM.

---

## PERFORMANCE DATA

---

Performance data given in this document is provided as a guide for the user in determining suitability and does not constitute a warranty. It may represent the result of OMRON's test conditions, and the users must correlate it to actual application requirements. Actual performance is subject to the OMRON Warranty and Limitations of Liability.

## CHANGE IN SPECIFICATIONS

---

Product specifications and accessories may be changed at any time based on improvements and other reasons.

It is our practice to change model numbers when published ratings or features are changed, or when significant construction changes are made. However, some specifications of the product may be changed without any notice. When in doubt, special model numbers may be assigned to fix or establish key specifications for your application on your request. Please consult with your OMRON representative at any time to confirm actual specifications of purchased products.

## DIMENSIONS AND WEIGHTS

---

Dimensions and weights are nominal and are not to be used for manufacturing purposes, even when tolerances are shown.

## ERRORS AND OMISSIONS

---

The information in this document has been carefully checked and is believed to be accurate; however, no responsibility is assumed for clerical, typographical, or proof-reading errors, or omissions.

## PROGRAMMABLE PRODUCTS

---

OMRON shall not be responsible for the user's programming of a programmable product, or any consequence thereof.

## COPYRIGHT AND COPY PERMISSION

---

This document shall not be copied for sales or promotions without permission.

This document is protected by copyright and is intended solely for use in conjunction with the product. Please notify us before copying or reproducing this document in any manner, for any other purpose. If copying or transmitting this document to another, please copy or transmit it in its entirety.





**Austria**

Tel: +43 (0) 2236 377 800  
[www.industrial.omron.at](http://www.industrial.omron.at)

**Belgium**

Tel: +32 (0) 2 466 24 80  
[www.industrial.omron.be](http://www.industrial.omron.be)

**Czech Republic**

Tel: +420 234 602 602  
[www.industrial.omron.cz](http://www.industrial.omron.cz)

**Denmark**

Tel: +45 43 44 00 11  
[www.industrial.omron.dk](http://www.industrial.omron.dk)

**Finland**

Tel: +358 (0) 207 464 200  
[www.industrial.omron.fi](http://www.industrial.omron.fi)

**France**

Tel: +33 (0) 1 56 63 70 00  
[www.industrial.omron.fr](http://www.industrial.omron.fr)

**Germany**

Tel: +49 (0) 2173 680 00  
[www.industrial.omron.de](http://www.industrial.omron.de)

**Hungary**

Tel: +36 1 399 30 50  
[www.industrial.omron.hu](http://www.industrial.omron.hu)

**Italy**

Tel: +39 02 326 81  
[www.industrial.omron.it](http://www.industrial.omron.it)

**Netherlands**

Tel: +31 (0) 23 568 11 00  
[www.industrial.omron.nl](http://www.industrial.omron.nl)

**Norway**

Tel: +47 (0) 22 65 75 00  
[www.industrial.omron.no](http://www.industrial.omron.no)

**Poland**

Tel: +48 (0) 22 645 78 60  
[www.industrial.omron.pl](http://www.industrial.omron.pl)

**Portugal**

Tel: +351 21 942 94 00  
[www.industrial.omron.pt](http://www.industrial.omron.pt)

**Russia**

Tel: +7 495 648 94 50  
[www.industrial.omron.ru](http://www.industrial.omron.ru)

**South-Africa**

Tel: +27 (0)11 579 2600  
[www.industrial.omron.co.za](http://www.industrial.omron.co.za)

**Spain**

Tel: +34 913 777 900  
[www.industrial.omron.es](http://www.industrial.omron.es)

**Sweden**

Tel: +46 (0) 8 632 35 00  
[www.industrial.omron.se](http://www.industrial.omron.se)

**Switzerland**

Tel: +41 (0) 41 748 13 13  
[www.industrial.omron.ch](http://www.industrial.omron.ch)

**Turkey**

Tel: +90 216 474 00 40  
[www.industrial.omron.com.tr](http://www.industrial.omron.com.tr)

**United Kingdom**

Tel: +44 (0) 870 752 08 61  
[www.industrial.omron.co.uk](http://www.industrial.omron.co.uk)

**More Omron representatives**  
[www.industrial.omron.eu](http://www.industrial.omron.eu)

*Authorised Distributor:***Control Systems**

• Programmable logic controllers • Human-machine interfaces • Remote I/O

**Motion & Drives**

• Motion controllers • Servo systems • Inverters

**Control Components**

• Temperature controllers • Power supplies • Timers • Counters • Programmable relays  
• Digital panel indicators • Electromechanical relays • Monitoring products • Solid-state relays  
• Limit switches • Pushbutton switches • Low voltage switch gear

**Sensing & Safety**

• Photoelectric sensors • Inductive sensors • Capacitive & pressure sensors • Cable connectors  
• Displacement & width-measuring sensors • Vision systems • Safety networks • Safety sensors  
• Safety units/relay units • Safety door/guard lock switches